

Angular Contact Ball Bearings

Tolerance Page 52
 Preload Page 95



● Design

Angular Contact Ball Bearings can sustain combined loads of simultaneously acting radial and axial loads because they have a contact angle (α).

The contact angle is defined as the angle between the line joining the points of contact between the ball and the raceways in the radial plane.

1. Single-row Angular Contact Ball Bearings

These bearings are designed with three contact angle classifications as shown in Table 1. Normally, contact angle A design and B design are fitted with a cage as shown in Table 2-1. High precision (JIS/ISO class 5 or higher) may be fitted with a machined cage of bronze or

phenolic resin or a polyamide cage. Contact angle C design are generally applied high precision, JIS (ISO) class 5 or higher, and are fitted with a machined phenolic resin cage or a polyamide cage.

Table 1. Contact Angle and Characteristics of Single-row Angular Contact Ball Bearings

Contact Angle Symbol	Example Bearing No.	Contact Angle (α)	Speed	Load capability comparison ⁽²⁾		Cross section
				Radial Load Direction (X)	Axial Load Direction (Y)	
A	7205 ⁽¹⁾	30°	—	—	—	
B	7205B	40°	Less	Less	Greater	
C	7205C	15°	Greater	Greater	Less	

Notes: ⁽¹⁾ Contact angle symbol "A" is omitted.
⁽²⁾ Axial load can be accommodated in one direction only.

Table 2-1. Angular Contact Ball Bearing Cage for Contact Angle Symbol A and B (For JIS/ISO class 0 or 6)

	Applicable Bore Diameter Number	
	Pressed Steel	Machined Brass
72, 72B	00~22	24~40
73, 73B	00~19	20~40

Table 2-2. Angular Contact Ball Bearing Cage for Contact Angle Symbol C

	Applicable Bore Diameter Number	
	Machined Synthetic Resin	Polyamide
70C	00~40	00~20
72C	00~26	00~20
73C	00~22	—

2. Combination Angular Contact Ball Bearings

Single-row Angular Contact Ball Bearings are seldom used as a single unit. Normally they are used as a combination of two and more units. High precision paired combination Angular Contact Ball Bearings (JIS/ISO class 5 or higher) are used for applications such as machine tool spindles and are usually preloaded. Three types of combinations are available:

- 1) DB, back - to - back
- 2) DF, face - to - face

3) DT, tandem
 Because clearance of matched set parts is adjusted before shipment, care should be taken to prevent mixing of parts from other sets. Load-carrying capability of combined Angular Contact Bearings are shown in Table 3. Flush ground bearings or Universal matching bearings are also available. DU can be mounted as back-to-back, face-to-face or in tandem.

Table 3. Load-carrying Characteristics of Combination Angular Contact Ball Bearings

Configuration	Load Center Distance (a)	Load Capability	Moment Load Rigidity	Cross Section
Back - to -Back (DB)	Long		Greater	
Face - to -Face (DF)	Short		Less	
Tandem (DT)	—		—	

3. Double-row Angular Contact Ball Bearings

This type bearings is made in two contact angle levels as shown in Table 4. They are selected according to sustained axial and moment load. Pressed steel cage are used for them. Some sizes of Double-row Angular Contact Ball Bearing are available with contact seals (2NS) or shields (ZZ).

Table 4. Double-row Angular Contact Ball Bearing Contact Angles and Symbols

Contact Angle Symbol	Contact Angle (α)	Example Bearing No.
None	20°	5205
A	30°	5205A

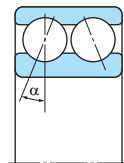

● Flush ground set combinations (Universal matching)

NACHI Angular Contact Ball Bearings with a suffix U are flush ground to permit the use of random combinations where two or more bearings are mounted.

7206B U
 7206CY U P4
 Flush ground (free set matching)

● Speed Limits

With respect to single-row or combination bearings, the dimension tables show limiting speed for bearings made with machined cages or a polyamide cages. For bearings made with pressed-cages, multiply the table limit by 0.8. For contact angle C design bearings, the table limiting speeds are applied to high precision bearings of class 5 or higher. These limiting speeds can be applied when a

high quality grease or oil is supplied in proper quantity under light load conditions. When Angular Contact Ball Bearings are used in combination of two or more units, or with larger preload to improve rigidity, the limiting speed must be decreased. Please contact NACHI for design assistance.

● Attention

- (1) If bearings are operated under severe conditions such as close to limiting speed, high temperature, or vibrating load, please consult NACHI.
- (2) Bearings with polyamide cage should be use at less than 120°C.
- (3) Combination Angular Contact Ball Bearings should not be mixed with those of other bearings.
- (4) When combination bearings with a optional preload is required, please contact NACHI.

Angular Contact Ball Bearings Single Mounting / Duplex Mounting

Bore Diameter: 10~17mm

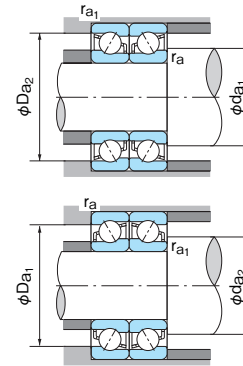
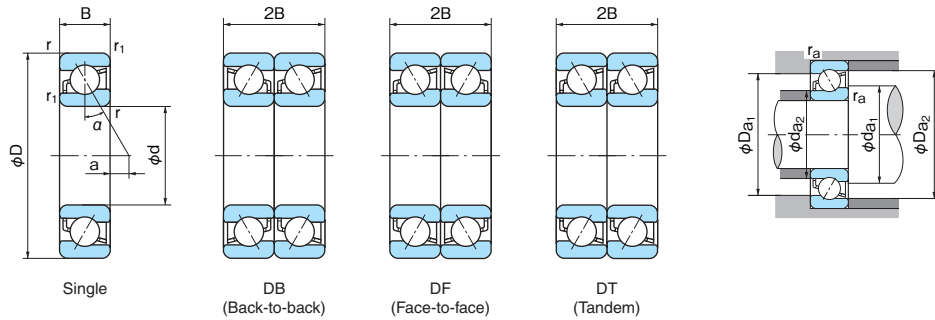

Dynamic equivalent radial load
 $Pr = XFr + YFa$

Contact angle	iFa / Cor	e	Single or DT		DB or DF					
			Fa / Fr > e	Fa / Fr ≤ e	Fa / Fr > e	Fa / Fr > e	Fa / Fr > e	Fa / Fr > e		
15°	0.015	0.38	X	Y	X	Y	X	Y	2.39	
	0.029	0.40	0.44	1.40	1	1.57	0.72	2.28	2.28	
	0.058	0.43		1.30		1.46		2.11	2.11	
	0.087	0.46		1.23		1.38		2.00	2.00	
	0.12	0.47	0.44	1.19	1	1.34	0.72	1.93	1.93	
	0.17	0.50		1.12		1.26		1.82	1.82	
	0.29	0.55		1.02		1.14		1.66	1.66	
	0.44	0.56	0.44	1.00	1	1.12	0.72	1.63	1.63	
	0.58	0.56		1.00		1.12		1.63	1.63	
	30°	—	0.8	0.39	0.76	1	0.78	0.63	1.24	1.24
	40°	—	1.14	0.35	0.57	1	0.55	0.57	0.93	0.93

Static equivalent radial load
 $Por = X_0Fr + Y_0Fa$

Contact angle	Single or DT		DB or DF	
	X ₀	Y ₀	X ₀	Y ₀
15°	0.5	0.46	1	0.92
30°	0.5	0.33	1	0.66
40°	0.5	0.26	1	0.52

Single or DT mounting When $Por < Fr$, use $Pr = Fr$

i = 2 for DB or DF mounting
 i = 1 for Single or DT mounting

Single or DT mounting When $Fa/Fr \leq e$, use $Pr = Fr$

Boundary dimensions (mm)	Load center (mm) a	Bearing No.				Basic dynamic load rating Cr (N)		Basic static load rating Cor (N)		1N=0.102kgf				Limiting speed (min ⁻¹)				Abutment and fillet dimensions (mm)				Mass (kg) Single	Bearing No.		
										Basic static load rating Cor (N)		Grease lubrication		Oil lubrication		da ₁ (min)		da ₂ (min)		Da ₁ (max)				Da ₂ (max)	
										Single	Duplex	Single	Duplex	Single	Duplex	Single	Duplex	Single	Duplex	Single	Duplex			Single	Duplex
10	26	8	0.3	0.15	1.2	7000	7000DB	7000DF	7000DT	5000	8150	2340	4650	23000	19000	31000	26000	12	12	24	25	0.3	0.15	0.022	7000
	26	8	0.3	0.15	-1.9	7000C	7000CDB	7000CDF	7000CDT	5350	8700	2500	5000	44000	35000	61000	49000	12	12	24	25	0.3	0.15	0.022	7000C
	30	9	0.6	0.3	1.3	7200	7200DB	7200DF	7200DT	5400	8800	2710	5400	22000	18000	30000	24000	15	12	25	27.4	0.6	0.3	0.034	7200
	30	9	0.6	0.3	-3.9	7200B	7200BDB	7200BDF	7200BDT	5150	8350	2570	5150	19000	16000	28000	22000	15	12	25	27.4	0.6	0.3	0.034	7200B
	30	9	0.6	0.3	-2.2	7200C	7200CDB	7200CDF	7200CDT	6950	11300	3300	6650	40000	32000	55000	44000	15	15	25	27.4	0.6	0.3	0.034	7200C
	35	11	0.6	0.3	1.0	7300	7300DB	7300DF	7300DT	9300	15100	4300	8600	20000	16000	26000	21000	15	12	30	32.4	0.6	0.3	0.055	7300
	35	11	0.6	0.3	3.9	7300B	7300BDB	7300BDF	7300BDT	8950	14500	4150	8250	18000	14000	24000	19000	15	12	30	32.4	0.6	0.3	0.055	7300B
	35	11	0.6	0.3	-2.8	7300C	7300CDB	7300CDF	7300CDT	9850	16000	4600	9250	36000	29000	49000	39000	15	15	30	32.4	0.6	0.3	0.055	7300C
12	28	8	0.3	0.15	1.7	7001	7001DB	7001DF	7001DT	5050	8800	2710	5700	22000	18000	29000	23000	14	14	26	27	0.3	0.15	0.024	7001
	28	8	0.3	0.15	-1.7	7001C	7001CDB	7001CDF	7001CDT	5800	9450	2910	5800	40000	32000	55000	44000	14	14	26	27	0.3	0.15	0.024	7001C
	32	10	0.6	0.3	1.4	7201	7201DB	7201DF	7201DT	7600	12400	3960	7950	20000	16000	27000	22000	17	14	27	29.4	0.6	0.3	0.040	7201
	32	10	0.6	0.3	4.2	7201B	7201BDB	7201BDF	7201BDT	7200	11700	3800	7550	17000	15000	24000	20000	17	14	27	29.4	0.6	0.3	0.040	7201B
	32	10	0.6	0.3	-2.5	7201C	7201CDB	7201CDF	7201CDT	7950	13000	3900	7750	36000	29000	50000	40000	17	17	27	29.4	0.6	0.3	0.040	7201C
	37	12	1	0.6	1.1	7301	7301DB	7301DF	7301DT	11200	18200	5250	10500	18000	15000	24000	20000	18	15	31	33.4	1	0.6	0.063	7301
	37	12	1	0.6	4.3	7301B	7301BDB	7301BDF	7301BDT	10800	17500	5050	10100	16000	13000	22000	18000	18	15	31	33.4	1	0.6	0.063	7301B
	37	12	1	0.6	-3.1	7301C	7301CDB	7301CDF	7301CDT	10800	17500	4900	9800	33000	26000	45000	36000	18	18	31	33.4	1	0.6	0.063	7301C
15	32	9	0.3	0.15	2.3	7002	7002DB	7002DF	7002DT	6150	9950	3400	6850	18000	15000	24000	20000	17	17	30	31	0.3	0.15	0.035	7002
	32	9	0.3	0.15	-1.8	7002C	7002CDB	7002CDF	7002CDT	6650	10800	3700	7450	34000	27000	47000	38000	17	17	30	31	0.3	0.15	0.035	7002C
	35	11	0.6	0.3	1.7	7202	7202DB	7202DF	7202DT	9050	14700	4700	9400	17000	14000	23000	19000	20	17	30	32.4	0.6	0.3	0.048	7202
	35	11	0.6	0.3	5.0	7202B	7202BDB	7202BDF	7202BDT	8600	14000	4500	8950	16000	12000	21000	17000	20	17	30	32.4	0.6	0.3	0.048	7202B
	35	11	0.6	0.3	-2.6	7202C	7202CDB	7202CDF	7202CDT	8700	14200	4550	9150	32000	26000	44000	35000	20	20	30	32.4	0.6	0.3	0.048	7202C
	42	13	1	0.6	1.7	7302	7302DB	7302DF	7302DT	13600	22000	7100	14200	16000	13000	21000	17000	21	18	36	38.4	1	0.6	0.085	7302
	42	13	1	0.6	5.5	7302B	7302BDB	7302BDF	7302BDT	12800	21000	6750	13500	14000	11000	19000	16000	21	18	36	38.4	1	0.6	0.085	7302B
	42	13	1	0.6	-3.1	7302C	7302CDB	7302CDF	7302CDT	13300	21700	6850	13700	28000	22000	39000	31000	21	21	36	38.4	1	0.6	0.085	7302C
17	35	10	0.3	0.15	2.5	7003	7003DB	7003DF	7003DT	6400	10400	3800	7650	17000	13000	22000	18000	19	19	33	34	0.3	0.15	0.045	7003
	35	10	0.3	0.15	-2.0	7003C	7003CDB	7003CDF	7003CDT	7000	11400	4150	8300	31000	25000	42000	34000	19	19	33	34	0.3	0.15	0.045	7003C
	40	12	0.6	0.3	2.2	7203	7203DB	7203DF	7203DT	11900	19400	6600	13200	16000	13000	21000	17000	22	19	35	37.4	0.6	0.3	0.070	7203
	40	12	0.6	0.3	6.0	7203B	7203BDB	7203BDF	7203BDT	11300	18400	6300	12600	14000	11000	19000	15000	22	19	35	37.4	0.6	0.3	0.070	7203B
	40	12	0.6	0.3	-2.7	7203C	7203CDB	7203CDF	7203CDT	10900	17800	5900	11800	28000	22000	39000	31000	22	22	35	37.4	0.6	0.3	0.070	7203C
	47	14	1	0.6	2.2	7303	7303DB	7303DF	7303DT	15900	25900	8650	17300	14000	11000	19000	15000	23	21	41	43.4	1	0.6	0.120	7303
	47	14	1	0.6	6.4	7303B	7303BDB	7303BDF	7303BDT	15200	24700	8250	16500	13000	10000	17000	14000	23	21	41	43.4	1	0.6	0.120	7303B
	47	14	1	0.6	-3.2	7303C	7303CDB	7303CDF	7303CDT	15900	25800	8350	16700	25000	20000	34000	27000	23	23	41	43.4	1	0.6	0.120	7303C

Remarks: 1. "a" means the distance between back face and load center.
 2. See page 122 regarding limiting speeds.

Angular Contact Ball Bearings Single Mounting / Duplex Mounting

Bore Diameter: 20~35mm

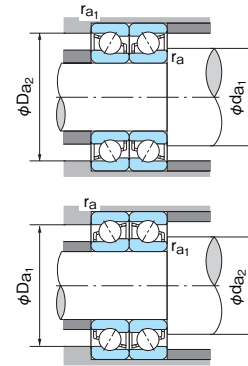
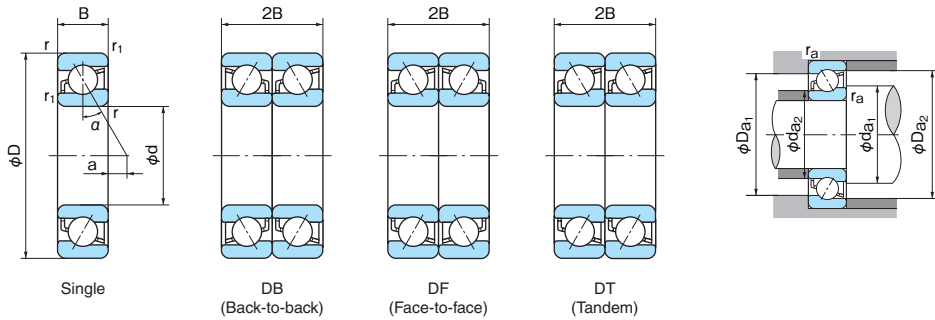

Dynamic equivalent radial load
Pr=XFr+YFa

Contact angle	iFa/Cor	e	Single or DT		DB or DF			
			Fa/Fr > e		Fa/Fr ≤ e		Fa/Fr > e	
			X	Y	X	Y	X	Y
15°	0.015	0.38		1.47		1.65		2.39
	0.029	0.40	0.44	1.40	1	1.57	0.72	2.28
	0.058	0.43		1.30		1.46		2.11
	0.087	0.46		1.23		1.38		2.00
	0.12	0.47	0.44	1.19	1	1.34	0.72	1.93
	0.17	0.50		1.12		1.26		1.82
	0.29	0.55		1.02		1.14		1.66
	0.44	0.56	0.44	1.00	1	1.12	0.72	1.63
	0.58	0.56		1.00		1.12		1.63
	—	—	—	—	—	—	—	—
30°	—	0.8	0.39	0.76	1	0.78	0.63	1.24
40°	—	—	—	—	—	—	—	—

Static equivalent radial load
Por=XoFr+YoFa

Contact angle	Single or DT		DB or DF	
	Xo	Yo	Xo	Yo
15°	0.5	0.46	1	0.92
30°	0.5	0.33	1	0.66
40°	0.5	0.26	1	0.52

Single or DT mounting When Por < XoFr, use Pr = Fr

i = 2 for DB or DF mounting
i = 1 for Single or DT mounting
Single or DT mounting When Fa/Fr ≤ e, use Pr = Fr

1N=0.102kgf

Boundary dimensions (mm)					Load center (mm) a	Bearing No.				Basic dynamic load rating Cr (N)		Basic static load rating Cor (N)		Limiting speed (min ⁻¹)				Abutment and fillet dimensions (mm)					Mass (kg) Single	Bearing No.	
d	D	B	r (min)	r1 (min)		Single	Duplex			Single	Duplex	Grease lubrication		Oil lubrication		da1 (min)	da2 (min)	Da1 (max)	Da2 (max)	ra (max)	ra1 (max)				
							7004	7004DB	7004DF			7004DT	Single	Duplex	Single							Duplex			Single
20	42	12	0.6	0.3	2.9	7004	7004DB	7004DF	7004DT	10300	16700	6050	12100	15000	12000	20000	16000	24	24	38	40	0.6	0.3	0.079	7004
	42	12	0.6	0.3	-2.4	7004C	7004CDB	7004CDF	7004CDT	11200	18200	6600	13200	26000	21000	35000	28000	24	24	38	40	0.6	0.3	0.079	7004C
	47	14	1	0.6	2.7	7204	7204DB	7204DF	7204DT	14500	23500	8300	16600	13000	10000	18000	14000	26	23	41	43.4	1	0.6	0.110	7204
	47	14	1	0.6	7.1	7204B	7204BDB	7204BDF	7204BDT	13700	22300	7850	15700	11000	9500	16000	13000	26	23	41	43.4	1	0.6	0.110	7204B
	47	14	1	0.6	-3.1	7204C	7204CDB	7204CDF	7204CDT	14700	23800	8150	16300	24000	19000	33000	26000	26	26	41	43.4	1	0.6	0.110	7204C
	52	15	1.1	0.6	2.9	7304	7304DB	7304DF	7304DT	18700	30500	10400	20800	13000	10000	17000	13000	27	25	45	47	1	0.6	0.150	7304
	52	15	1.1	0.6	7.6	7304B	7304BDB	7304BDF	7304BDT	17800	28900	9900	19800	10000	9000	15000	12000	27	25	45	47	1	0.6	0.150	7304B
52	15	1.1	0.6	-3.2	7304C	7304CDB	7304CDF	7304CDT	18600	30000	10000	20000	22000	18000	31000	25000	27	27	45	47	1	0.6	0.150	7304C	
25	47	12	0.6	0.3	4.4	7005	7005DB	7005DF	7005DT	11300	18400	7400	14800	13000	10000	17000	13000	29	29	43	45	0.6	0.3	0.091	7005
	47	12	0.6	0.3	-1.8	7005C	7005CDB	7005CDF	7005CDT	12900	21000	8650	17300	22000	18000	31000	25000	29	29	43	45	0.6	0.3	0.091	7005C
	52	15	1	0.6	3.6	7205	7205DB	7205DF	7205DT	16200	26300	10200	20500	12000	9500	15000	12000	31	28	46	48.4	1	0.6	0.135	7205
	52	15	1	0.6	8.9	7205B	7205BDB	7205BDF	7205BDT	15300	24800	9700	19400	9500	8000	14000	11000	31	28	46	48.4	1	0.6	0.135	7205B
	52	15	1	0.6	-3.1	7205C	7205CDB	7205CDF	7205CDT	16700	27100	10300	20700	21000	17000	29000	23000	31	31	46	48.4	1	0.6	0.135	7205C
	62	17	1.1	0.6	4.1	7305	7305DB	7305DF	7305DT	26400	43000	15800	31500	10000	8500	14000	11000	32	30	55	57	1	0.6	0.245	7305
	62	17	1.1	0.6	9.8	7305B	7305BDB	7305BDF	7305BDT	25100	40500	15100	30000	8500	7300	12000	10000	32	30	55	57	1	0.6	0.245	7305B
62	17	1.1	0.6	-3.4	7305C	7305CDB	7305CDF	7305CDT	26600	43000	15500	31000	18000	14000	25000	20000	32	32	55	57	1	0.6	0.245	7305C	
30	55	13	1	0.6	5.8	7006	7006DB	7006DF	7006DT	14500	23600	10100	20300	12000	8500	14000	11000	35	35	50	52	1	0.6	0.135	7006
	55	13	1	0.6	-1.6	7006C	7006CDB	7006CDF	7006CDT	16000	25900	11100	24000	19000	15000	26000	21000	35	35	50	52	1	0.6	0.135	7006C
	62	16	1	0.6	5.3	7206	7206DB	7206DF	7206DT	22500	36500	14800	29600	10000	8000	13000	10000	36	33	56	58.4	1	0.6	0.210	7206
	62	16	1	0.6	11.3	7206B	7206BDB	7206BDF	7206BDT	21200	34500	13900	27900	8500	7000	12000	9500	36	33	56	58.4	1	0.6	0.210	7206B
	62	16	1	0.6	-2.7	7206C	7206CDB	7206CDF	7206CDT	23200	37500	14900	29700	18000	14000	24000	19000	36	36	56	58.4	1	0.6	0.210	7206C
	72	19	1.1	0.6	5.2	7306	7306DB	7306DF	7306DT	33500	54500	22400	44500	9000	7000	12000	9500	37	35	65	67	1	0.6	0.360	7306
	72	19	1.1	0.6	11.9	7306B	7306BDB	7306BDF	7306BDT	32000	52000	21000	42000	7500	6100	10000	8500	37	35	65	67	1	0.6	0.360	7306B
72	19	1.1	0.6	-3.6	7306C	7306CDB	7306CDF	7306CDT	32500	52500	20400	40500	16000	13000	22000	18000	37	37	65	67	1	0.6	0.360	7306C	
35	62	14	1	0.6	7	7007	7007DB	7007DF	7007DT	17500	28500	12600	25200	9500	7500	13000	10000	40	40	57	59	1	0.6	0.170	7007
	62	14	1	0.6	-1.4	7007C	7007CDB	7007CDF	7007CDT	19300	31000	13700	27500	16000	13000	23000	18000	40	40	57	59	1	0.6	0.170	7007C
	72	17	1.1	0.6	6.9	7207	7207DB	7207DF	7207DT	29700	48000	20000	40000	8500	7000	11000	9500	42	40	65	67	1	0.6	0.295	7207
	72	17	1.1	0.6	14.1	7207B	7207BDB	7207BDF	7207BDT	28000	45500	19000	38000	7500	6000	10000	8000	42	40	65	67	1	0.6	0.295	7207B
	72	17	1.1	0.6	-2.8	7207C	7207CDB	7207CDF	7207CDT	30500	49500	20100	40000	15000	12000	21000	17000	42	42	65	67	1	0.6	0.295	7207C
	80	21	1.5	1	6.1	7307	7307DB	7307DF	7307DT	40000	65000	26300	52500	8000	6300	10000	8500	44	40	71	74.6	1.5	1	0.475	7307
	80	21	1.5	1	13.7	7307B	7307BDB	7307BDF	7307BDT	37500	61500	24900	49500	7000	5500	9500	7500	44	40	71	74.6	1.5	1	0.475	7307B
80	21	1.5	1	-3.9	7307C	7307CDB	7307CDF	7307CDT	40500	66000	26000	52000	14000	11000	19000	15000	44	44	71	74.6	1.5	1	0.475	7307C	

Remarks: 1. "a" means the distance between back face and load center.
2. See page 122 regarding limiting speeds.

Angular Contact Ball Bearings Single Mounting / Duplex Mounting

Bore Diameter: 40~55mm

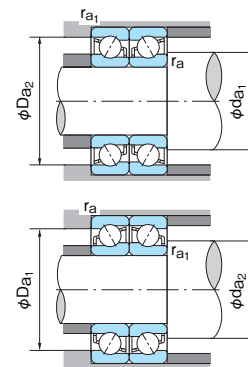
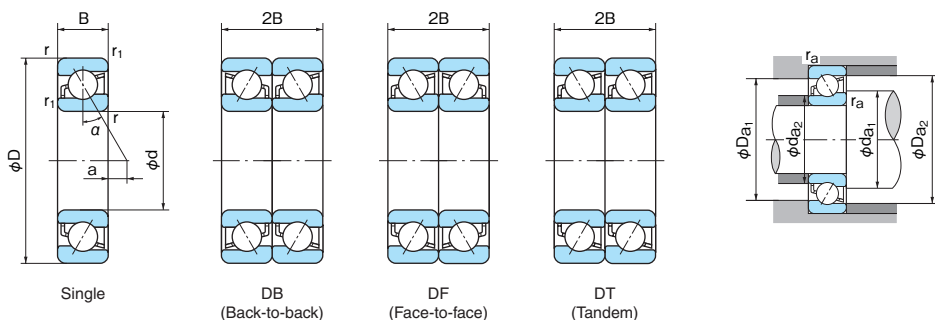

Dynamic equivalent radial load
 $P_r = X F_r + Y F_a$

Static equivalent radial load
 $P_o = X_o F_r + Y_o F_a$

Contact angle	iFa Cor	e	Single or DT				DB or DF				Contact angle	Single or DT		DB or DF		
			Fa/Fr > e		Fa/Fr ≤ e		Fa/Fr > e		Fa/Fr ≤ e			X _o	Y _o	X _o	Y _o	
			X	Y	X	Y	X	Y	X	Y						
15°	0.015	0.38					1.47	1.65			2.39	15°	0.5	0.46	1	0.92
	0.029	0.40	0.44	1.40	1	1.57	0.72	2.28			2.28	30°	0.5	0.33	1	0.66
	0.058	0.43		1.30		1.46		2.11			2.11	40°	0.5	0.26	1	0.52
	0.087	0.46		1.23		1.38		2.00			2.00					
	0.12	0.47	0.44	1.19	1	1.34	0.72	1.93			1.93					
	0.17	0.50		1.12		1.26		1.82			1.82					
	0.29	0.55		1.02		1.14		1.66			1.66					
	0.44	0.56	0.44	1.00	1	1.12	0.72	1.63			1.63					
	0.58	0.56		1.00		1.12		1.63			1.63					
	0.78	0.56		1.00		1.12		1.63			1.63					
30°	—	0.8	0.39	0.76	1	0.78	0.63	1.24			1.24					
40°	—	1.14	0.35	0.57	1	0.55	0.57	0.93			0.93					

Single or DT mounting When $P_o < F_r$, use $P_r = F_r$

- i = 2 for DB or DF mounting
- i = 1 for Single or DT mounting
- Single or DT mounting When $F_a/F_r \leq e$, use $P_r = F_r$

Boundary dimensions (mm)					Load center (mm) a	Bearing No.				Basic dynamic load rating Cr (N)		Basic static load rating Cor (N)		Limiting speed (min ⁻¹)				Abutment and fillet dimensions (mm)				Mass (kg) Single	Bearing No.		
d	D	B	r (min)	r ₁ (min)		Single	Duplex			Single	Duplex	Single	Duplex	Grease lubrication		Oil lubrication		d _{a1} (min)	d _{a2} (min)	D _{a1} (max)	D _{a2} (max)			r _a (max)	r _{a1} (max)
							7008	7008DB	7008DF					7008DT	7008CDF	7008CDB	7008BDF								
40	68	15	1	0.6	8.2	7008	7008DB	7008DF	7008DT	18800	30500	14500	29000	8500	6600	11000	9000	45	45	63	65	1	0.6	0.210	7008
	68	15	1	0.6	-1.3	7008C	7008CDB	7008CDF	7008CDT	20700	33500	16000	32000	15000	12000	20000	16000	45	45	63	65	1	0.6	0.210	7008C
	80	18	1.1	0.6	8.3	7208	7208DB	7208DF	7208DT	35000	57500	25200	50500	7500	6000	10000	8000	47	45	73	75	1	0.6	0.380	7208
	80	18	1.1	0.6	16.2	7208B	7208BDB	7208BDF	7208BDT	33000	54000	23700	47500	6700	5300	9200	7200	47	45	73	75	1	0.6	0.380	7208B
	80	18	1.1	0.6	-2.1	7208C	7208CDB	7208CDF	7208CDT	36500	59500	25400	50500	13000	10000	18000	14000	47	47	73	75	1	0.6	0.380	7208C
	90	23	1.5	1	7.3	7308	7308DB	7308DF	7308DT	49000	79000	33000	66000	7000	5500	9200	7500	49	45	81	84.6	1.5	1	0.655	7308
	90	23	1.5	1	15.8	7308B	7308BDB	7308BDF	7308BDT	46000	75000	31000	62500	6300	5000	8500	6700	49	45	81	84.6	1.5	1	0.655	7308B
90	23	1.5	1	-4.0	7308C	7308CDB	7308CDF	7308CDT	49500	80500	32500	65500	12000	9600	17000	13000	49	49	81	84.6	1.5	1	0.655	7308C	
45	75	16	1	0.6	9.3	7009	7009DB	7009DF	7009DT	22200	36000	17600	35000	7500	6000	10000	8000	50	50	70	72	1	0.6	0.265	7009
	75	16	1	0.6	-1.1	7009C	7009CDB	7009CDF	7009CDT	24600	40000	19400	39000	13000	10000	18000	14000	50	50	70	72	1	0.6	0.265	7009C
	85	19	1.1	0.6	9.3	7209	7209DB	7209DF	7209DT	39500	64500	28800	57500	7000	5500	9200	7500	52	50	78	80	1	0.6	0.430	7209
	85	19	1.1	0.6	17.8	7209B	7209BDB	7209BDF	7209BDT	37000	60500	27100	54000	6300	5000	8500	6700	52	50	78	80	1	0.6	0.430	7209B
	85	19	1.1	0.6	-2.0	7209C	7209CDB	7209CDF	7209CDT	41000	66500	29000	58000	12000	9600	17000	13000	52	52	78	80	1	0.6	0.430	7209C
	100	25	1.5	1	8.4	7309	7309DB	7309DF	7309DT	63500	103000	43500	87000	6300	5000	8500	6700	54	50	91	94.6	1.5	1	0.875	7309
	100	25	1.5	1	18.0	7309B	7309BDB	7309BDF	7309BDT	60000	97500	41500	82500	5600	4500	7500	6000	54	50	91	94.6	1.5	1	0.875	7309B
100	25	1.5	1	-4.1	7309C	7309CDB	7309CDF	7309CDT	63500	103000	43500	87000	11000	8800	15000	12000	54	54	91	94.6	1.5	1	0.875	7309C	
50	80	16	1	0.6	10.8	7010	7010DB	7010DF	7010DT	23600	38500	20000	40000	7000	5500	9200	7500	55	55	75	77	1	0.6	0.285	7010
	80	16	1	0.6	-0.5	7010C	7010CDB	7010CDF	7010CDT	26200	42500	22000	44000	12000	9600	17000	13000	55	55	75	77	1	0.6	0.285	7010C
	90	20	1.1	0.6	10.2	7210	7210DB	7210DF	7210DT	41000	67000	31500	63000	6300	5300	8500	6700	57	55	83	85	1	0.6	0.485	7210
	90	20	1.1	0.6	19.4	7210B	7210BDB	7210BDF	7210BDT	38500	63000	29600	59000	5600	4500	7500	6000	57	55	83	85	1	0.6	0.485	7210B
	90	20	1.1	0.6	-1.9	7210C	7210CDB	7210CDF	7210CDT	43000	70000	32000	63500	11000	8800	16000	13000	57	57	83	85	1	0.6	0.485	7210C
	110	27	2	1	9.6	7310	7310DB	7310DF	7310DT	74000	121000	52000	104000	5600	4500	7500	6000	60	56	100	104	2	1	1.14	7310
	110	27	2	1	20.1	7310B	7310BDB	7310BDF	7310BDT	70500	114000	49500	98500	5000	4000	6700	5300	60	56	100	104	2	1	1.14	7310B
110	27	2	1	-4.3	7310C	7310CDB	7310CDF	7310CDT	75500	122000	51000	102000	10000	8000	14000	11000	60	60	100	104	2	1	1.14	7310C	
55	90	18	1.1	0.6	11.9	7011	7011DB	7011DF	7011DT	31000	50500	26200	52500	6300	5000	8500	6700	61	61	84	86	1	0.6	0.420	7011
	90	18	1.1	0.6	-0.6	7011C	7011CDB	7011CDF	7011CDT	34500	56000	28800	57500	11000	8800	15000	12000	61	61	84	86	1	0.6	0.420	7011C
	100	21	1.5	1	11.9	7211	7211DB	7211DF	7211DT	51000	83000	39500	79000	6000	4500	7500	6300	64	60	91	94.6	1.5	1	0.635	7211
	100	21	1.5	1	22.1	7211B	7211BDB	7211BDF	7211BDT	48000	78000	37500	74500	5300	4000	7000	5500	64	60	91	94.6	1.5	1	0.635	7211B
	100	21	1.5	1	-1.6	7211C	7211CDB	7211CDF	7211CDT	53000	86500	40000	80000	10000	8000	14000	11000	64	64	91	94.6	1.5	1	0.635	7211C
	120	29	2	1	10.8	7311	7311DB	7311DF	7311DT	85500	139000	61500	123000	5000	4000	7000	5500	65	61	110	114	2	1	1.45	7311
	120	29	2	1	22.3	7311B	7311BDB	7311BDF	7311BDT	81000	132000	58000	116000	4500	3500	6200	5000	65	61	110	114	2	1	1.45	7311B
120	29	2	1	-4.4	7311C	7311CDB	7311CDF	7311CDT	87000	142000	60000	121000	9100	7300	13000	10000	65	65	110	114	2	1	1.45	7311C	

Remarks: 1. "a" means the distance between back face and load center.
 2. See page 122 regarding limiting speeds.

Angular Contact Ball Bearings Single Mounting / Duplex Mounting

Bore Diameter: 60~75mm

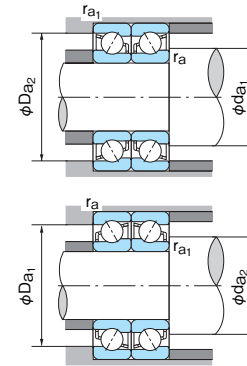
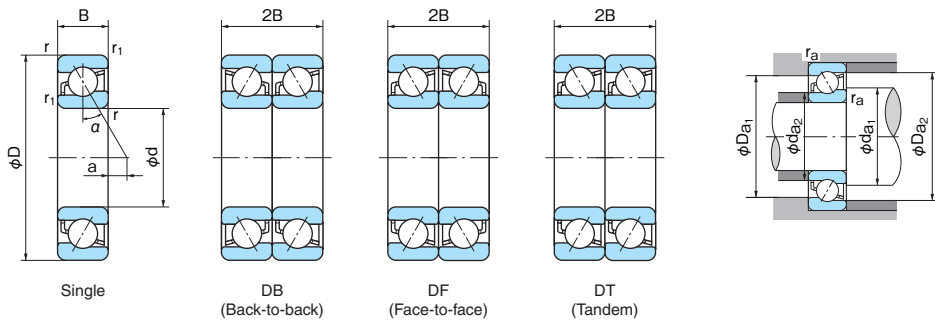

Dynamic equivalent radial load
Pr = XFr + YFa

Static equivalent radial load
Por = XoFr + YoFa

Contact angle	iFa/Cor	e	Single or DT				DB or DF				Contact angle	Single or DT		DB or DF	
			Fa/Fr > e		Fa/Fr ≤ e		Fa/Fr > e		Fa/Fr ≤ e			Xo	Yo	Xo	Yo
			X	Y	X	Y	X	Y	X	Y					
15°	0.015	0.38			1.47	1.65					15°	0.5	0.46	1	0.92
	0.029	0.40	0.44	1.40	1	1.57	0.72	2.28		30°	0.5	0.33	1	0.66	
	0.058	0.43		1.30		1.46		2.11		40°	0.5	0.26	1	0.52	
	0.087	0.46		1.23		1.38		2.00							
	0.12	0.47	0.44	1.19	1	1.34	0.72	1.93							
	0.17	0.50		1.12		1.26		1.82							
	0.29	0.55		1.02		1.14		1.66							
	0.44	0.56	0.44	1.00	1	1.12	0.72	1.63							
	0.58	0.56		1.00		1.12		1.63							
	0.78	0.56		1.00		1.12		1.63							
30°	—	0.8	0.39	0.76	1	0.78	0.63	1.24							
	—	1.14	0.35	0.57	1	0.55	0.57	0.93							

Single or DT mounting When Por < Fr, use Pr = Fr

i = 2 for DB or DF mounting
i = 1 for Single or DT mounting
Single or DT mounting When Fa/Fr ≤ e, use Pr = Fr

1N=0.102kgf

Boundary dimensions (mm)	Load center (mm) a	Bearing No.				Basic dynamic load rating Cr (N)		Basic static load rating Cor (N)		Limiting speed (min ⁻¹)				Abutment and fillet dimensions (mm)					Mass (kg) Single	Bearing No.	
										Grease lubrication		Oil lubrication		da1 (min)	da2 (min)	Da1 (max)	Da2 (max)	ra (max)			ra1 (max)
										Single	Duplex	Single	Duplex	Single	Duplex	Single	Duplex	Single			Duplex
60	13.4	7012	7012DB	7012DF	7012DT	32000	51500	28000	56000	6000	4500	7600	6200	66	66	89	91	1	0.6	0.450	7012
	-0.1	7012C	7012CDB	7012CDF	7012CDT	35500	57500	30500	61500	10000	8000	14000	11000	66	66	89	91	1	0.6	0.450	7012C
	13.5	7212	7212DB	7212DF	7212DT	62000	100000	48500	97500	5300	4300	7100	5600	69	65	101	104.6	1.5	1	0.820	7212
	24.7	7212B	7212BDB	7212BDF	7212BDT	58000	94000	46000	92000	4800	3800	6300	5000	69	65	101	104.6	1.5	1	0.820	7212B
	-1.2	7212C	7212CDB	7212CDF	7212CDT	64500	105000	49500	98500	9400	7500	13000	10000	69	69	101	104.6	1.5	1	0.820	7212C
	11.9	7312	7312DB	7312DF	7312DT	98000	159000	71500	148000	4800	3800	6300	5000	72	67	118	123	2	1	1.81	7312
	24.4	7312B	7312BDB	7312BDF	7312BDT	92500	151000	67500	135000	4300	3400	5500	4500	72	67	118	123	2	1	1.81	7312B
	-4.5	7312C	7312CDB	7312CDF	7312CDT	99500	162000	70000	140000	8400	6700	12000	9600	72	72	118	123	2	1	1.81	7312C
65	14.8	7013	7013DB	7013DF	7013DT	33500	54500	31000	62500	5600	4300	7100	6000	71	71	94	96	1	0.6	0.470	7013
	0.5	7013C	7013CDB	7013CDF	7013CDT	37500	60500	34500	69000	9700	7800	13000	10000	71	71	94	96	1	0.6	0.470	7013C
	15.2	7213	7213DB	7213DF	7213DT	70000	114000	57800	116000	4900	3900	6500	5300	74	70	111	114.6	1.5	1	1.02	7213
	27.4	7213B	7213BDB	7213BDF	7213BDT	66000	107000	54500	109000	4300	3400	5600	4600	74	70	111	114.6	1.5	1	1.02	7213B
	-0.8	7213C	7213CDB	7213CDF	7213CDT	73500	120000	59000	118000	8600	6900	12000	9600	74	74	111	114.6	1.5	1	1.02	7213C
	13.1	7313	7313DB	7313DF	7313DT	111000	180000	82000	165000	4400	3600	5800	4700	77	72	128	133	2	1	2.22	7313
	26.6	7313B	7313BDB	7313BDF	7313BDT	105000	170000	77500	155000	4000	3200	5300	4200	77	72	128	133	2	1	2.22	7313B
-4.7	7313C	7313CDB	7313CDF	7313CDT	113000	183000	81000	162000	7800	6200	11000	8800	77	77	128	133	2	1	2.22	7313C	
70	16.0	7014	7014DB	7014DF	7014DT	42500	69000	39500	78500	5000	4000	6600	5300	76	76	104	106	1	0.6	0.660	7014
	0.4	7014C	7014CDB	7014CDF	7014CDT	47000	76500	43000	86500	8900	7100	12000	9600	76	76	104	106	1	0.6	0.660	7014C
	16.1	7214	7214DB	7214DF	7214DT	76500	124000	63500	127000	4500	3800	6300	5000	79	75	116	119.6	1.5	1	1.12	7214
	29.0	7214B	7214BDB	7214BDF	7214BDT	71500	116000	59500	120000	4300	3200	5600	4500	79	75	116	119.6	1.5	1	1.12	7214B
	-0.7	7214C	7214CDB	7214CDF	7214CDT	80000	130000	65000	130000	8200	6600	11000	8800	79	79	116	119.6	1.5	1	1.12	7214C
	14.3	7314	7314DB	7314DF	7314DT	125000	203000	94000	188000	4000	3200	5300	4300	82	77	138	143	2	1	2.70	7314
	28.7	7314B	7314BDB	7314BDF	7314BDT	118000	191000	88500	177000	3600	2900	4800	3900	82	77	138	143	2	1	2.70	7314B
-4.8	7314C	7314CDB	7314CDF	7314CDT	127000	206000	92500	185000	7300	5800	10000	8000	82	82	138	143	2	1	2.70	7314C	
75	17.4	7015	7015DB	7015DF	7015DT	43500	70500	41500	83000	4800	3800	6300	5000	81	81	109	111	1	0.6	0.695	7015
	1.0	7015C	7015CDB	7015CDF	7015CDT	48500	78500	46000	92000	8400	6700	12000	9600	81	81	109	111	1	0.6	0.695	7015C
	17.1	7215	7215DB	7215DF	7215DT	79000	129000	68500	137000	4300	3400	5800	4700	84	80	121	124.6	1.5	1	1.23	7215
	30.6	7215B	7215BDB	7215BDF	7215BDT	74000	120000	64000	128000	4000	3200	5300	4300	84	80	121	124.6	1.5	1	1.23	7215B
	-0.7	7215C	7215CDB	7215CDF	7215CDT	83500	135000	70000	141000	7800	6200	11000	8800	84	84	121	124.6	1.5	1	1.23	7215C
	15.4	7315	7315DB	7315DF	7315DT	136000	221000	106000	212000	3800	3000	5000	4000	87	82	148	153	2	1	3.15	7315
	30.9	7315B	7315BDB	7315BDF	7315BDT	128000	208000	100000	200000	3400	2700	4500	3600	87	82	148	153	2	1	3.15	7315B
	-4.9	7315C	7315CDB	7315CDF	7315CDT	138000	225000	104000	209000	6800	5400	9400	7500	87	87	148	153	2	1	3.15	7315C

Remarks: 1. "a" means the distance between back face and load center.
2. See page 122 regarding limiting speeds.

Angular Contact Ball Bearings Single Mounting / Duplex Mounting

Bore Diameter: 80~95mm

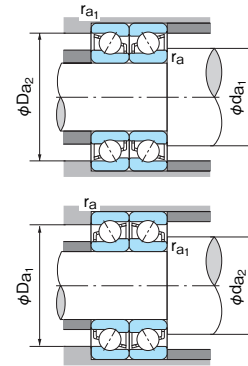
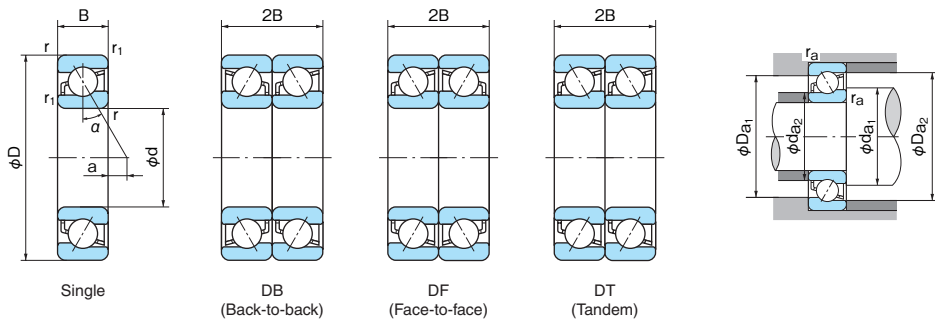

Dynamic equivalent radial load
 $P_r = X F_r + Y F_a$

Static equivalent radial load
 $P_o = X_o F_r + Y_o F_a$

Contact angle	iFa Cor	e	Single or DT		DB or DF				Contact angle	Single or DT		DB or DF		
			Fa/Fr > e	Fa/Fr ≤ e	X	Y	X	Y		Xo	Yo	Xo	Yo	
			X	Y	X	Y	X	Y		Xo	Yo	Xo	Yo	
15°	0.015	0.38			1.47	1.65			1.47	1.65	0.5	0.46	1	0.92
	0.029	0.40	0.44	1.40	1	1.57	0.72	2.28	0.5	0.33	1	0.66		
	0.058	0.43		1.30		1.46		2.11	0.5	0.26	1	0.52		
	0.087	0.46		1.23		1.38		2.00						
	0.12	0.47	0.44	1.19	1	1.34	0.72	1.93						
	0.17	0.50		1.12		1.26		1.82						
	0.29	0.55		1.02		1.14		1.66						
	0.44	0.56	0.44	1.00	1	1.12	0.72	1.63						
	0.58	0.56		1.00		1.12		1.63						
	—	—	0.8	0.39	0.76	1	0.78	0.63	1.24					
30°	—	—	1.14	0.35	0.57	1	0.55	0.57	0.93					

Single or DT mounting When $P_o < X_o F_r$, use $P_r = F_r$

i = 2 for DB or DF mounting
 i = 1 for Single or DT mounting
 Single or DT mounting When $F_a/F_r \leq e$, use $P_r = F_r$

Boundary dimensions (mm)	Load center (mm) a	Bearing No.	Basic dynamic load rating Cr (N)	Basic static load rating Cor (N)	1N=0.102kgf	Limiting speed (min ⁻¹)	Abutment and fillet dimensions (mm)	Mass (kg) Single	Bearing No.																
										Single		Duplex		Grease lubrication		Oil lubrication		da1 (min)	da2 (min)	Da1 (max)	Da2 (max)	ra (max)	ra1 (max)		
										Single	Duplex	Single	Duplex	Single	Duplex	Single	Duplex								
80	125	22	1.1	0.6	18.6	7016	7016DB	7016DF	7016DT	53500	86500	50500	101000	4400	3500	5800	4600	86	86	119	121	1	0.6	0.925	7016
	125	22	1.1	0.6	0.8	7016C	7016CDB	7016CDF	7016CDT	59000	96000	55500	111000	7800	6200	11000	8800	86	86	119	121	1	0.6	0.925	7016C
	140	26	2	1	18.8	7216	7216DB	7216DF	7216DT	89000	145000	76500	153000	4000	3200	5400	4300	90	86	130	134	2	1	1.50	7216
	140	26	2	1	33.2	7216B	7216BDB	7216BDF	7216BDT	83500	135000	71500	143000	3600	2800	5000	4000	90	86	130	134	2	1	1.50	7216B
	140	26	2	1	-0.3	7216C	7216CDB	7216CDF	7216CDT	93500	152000	78000	156000	7300	5800	10000	8000	90	90	130	134	2	1	1.50	7216C
	170	39	2.1	1.1	16.6	7316	7316DB	7316DF	7316DT	147000	239000	119000	238000	3600	2800	4800	3800	92	87	158	163	2	1	4.18	7316
	170	39	2.1	1.1	33.0	7316B	7316BDB	7316BDF	7316BDT	139000	226000	112000	225000	3200	2500	4200	3400	92	87	158	163	2	1	4.18	7316B
170	39	2.1	1.1	-5.1	7316C	7316CDB	7316CDF	7316CDT	150000	243000	117000	235000	6400	5100	8800	7000	92	92	158	163	2	1	4.18	7316C	
85	130	22	1.1	0.6	20	7017	7017DB	7017DF	7017DT	54500	88500	53500	107000	4100	3300	5500	4400	91	91	124	126	1	0.6	0.960	7017
	130	22	1.1	0.6	1.4	7017C	7017CDB	7017CDF	7017CDT	60500	98500	59000	118000	7400	5900	10000	8000	91	91	124	126	1	0.6	0.960	7017C
	150	28	2	1	19.9	7217	7217DB	7217DF	7217DT	103000	167000	89500	179000	3800	3000	5000	4000	95	91	140	144	2	1	1.87	7217
	150	28	2	1	35.4	7217B	7217BDB	7217BDF	7217BDT	96500	159000	83500	168000	3400	2600	4500	3800	95	91	140	144	2	1	1.87	7217B
	150	28	2	1	-0.4	7217C	7217CDB	7217CDF	7217CDT	100000	163000	85000	170000	6800	5400	9400	7500	95	95	140	144	2	1	1.87	7217C
	180	41	3	1.1	17.7	7317	7317DB	7317DF	7317DT	159000	258000	133000	266000	3400	2600	4500	3600	99	92	166	173	2.5	1	4.90	7317
	180	41	3	1.1	35.2	7317B	7317BDB	7317BDF	7317BDT	150000	244000	125000	251000	3000	2400	4000	3200	99	92	166	173	2.5	1	4.90	7317B
180	41	3	1.1	-5.2	7317C	7317CDB	7317CDF	7317CDT	162000	263000	131000	262000	6000	4800	8300	6600	99	99	166	173	2.5	1	4.90	7317C	
90	140	24	1.5	1	21.2	7018	7018DB	7018DF	7018DT	65000	106000	63000	126000	3800	3200	5200	4200	97	97	133	135.6	1.5	1	1.26	7018
	140	24	1.5	1	1.3	7018C	7018CDB	7018CDF	7018CDT	72000	117000	69500	139000	7000	5600	9600	7800	97	97	133	135.6	1.5	1	1.26	7018C
	160	30	2	1	21.1	7218	7218DB	7218DF	7218DT	118000	191000	103000	206000	3500	2800	4700	3700	100	96	150	154	2	1	2.30	7218
	160	30	2	1	37.5	7218B	7218BDB	7218BDF	7218BDT	110000	179000	97000	194000	3200	2500	4300	3400	100	96	150	154	2	1	2.30	7218B
	160	30	2	1	-0.6	7218C	7218CDB	7218CDF	7218CDT	124000	201000	105000	211000	6400	5100	8800	7000	100	100	150	154	2	1	2.30	7218C
	190	43	3	1.1	18.9	7318	7318DB	7318DF	7318DT	171000	277000	147000	295000	3200	2600	4300	3400	104	97	176	183	2.5	1	5.76	7318
	190	43	3	1.1	37.3	7318B	7318BDB	7318BDF	7318BDT	161000	262000	139000	278000	2800	2300	3800	3000	104	97	176	183	2.5	1	5.76	7318B
190	43	3	1.1	-5.3	7318C	7318CDB	7318CDF	7318CDT	174000	282000	146000	291000	5700	4600	7900	6300	104	104	176	183	2.5	1	5.76	7318C	
95	145	24	1.5	1	22.6	7019	7019DB	7019DF	7019DT	67000	109000	66500	133000	3800	3100	5200	4200	102	102	138	140.6	1.5	1	1.36	7019
	145	24	1.5	1	1.9	7019C	7019CDB	7019CDF	7019CDT	74000	120000	73500	147000	6700	5400	9200	7400	102	102	138	140.6	1.5	1	1.36	7019C
	170	32	2.1	1.1	22.2	7219	7219DB	7219DF	7219DT	126000	205000	112000	225000	3400	2600	4500	3600	107	102	158	163	2	1	2.78	7219
	170	32	2.1	1.1	39.7	7219B	7219BDB	7219BDF	7219BDT	120000	195000	105000	210000	3000	2400	4000	3200	107	102	158	163	2	1	2.78	7219B
	170	32	2.1	1.1	-0.7	7219C	7219CDB	7219CDF	7219CDT	133000	217000	115000	230000	6000	4800	8300	6600	107	107	158	163	2	1	2.78	7219C
	200	45	3	1.1	20.1	7319	7319DB	7319DF	7319DT	183000	297000	163000	325000	3000	2400	4000	3200	109	102	186	193	2.5	1	6.68	7319
	200	45	3	1.1	39.5	7319B	7319BDB	7319BDF	7319BDT	172000	280000	153000	305000	2500	2200	3600	3000	109	102	186	193	2.5	1	6.68	7319B
200	45	3	1.1	-5.5	7319C	7319CDB	7319CDF	7319CDT	186000	300000	161000	320000	5400	4300	7500	6000	109	109	186	193	2.5	1	6.68	7319C	

Remarks: 1. "a" means the distance between back face and load center.
 2. See page 122 regarding limiting speeds.

Angular Contact Ball Bearings Single Mounting / Duplex Mounting

Bore Diameter: 100~120mm

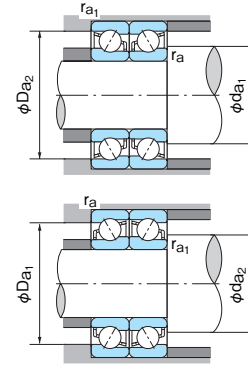
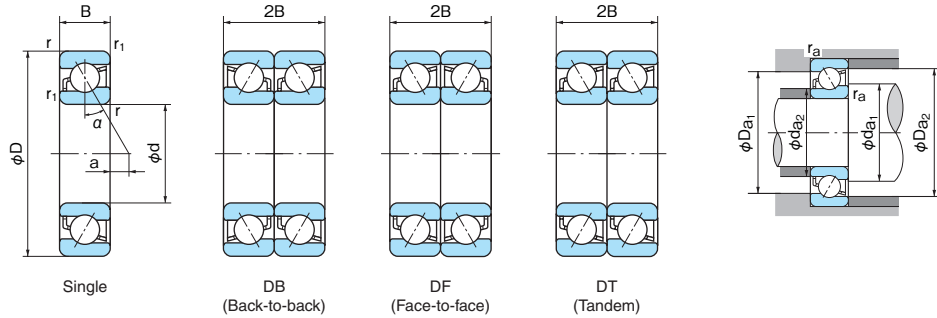

Dynamic equivalent radial load
Pr = XFr + YFa

Contact angle	iFa/Cor	e	Single or DT				DB or DF			
			Fa/Fr > e		Fa/Fr ≤ e		Fa/Fr > e		Fa/Fr ≤ e	
			X	Y	X	Y	X	Y	X	Y
15°	0.015	0.38					1.47	1.65		2.39
	0.029	0.40	0.44	1.40	1	1.57	0.72	2.28		2.28
	0.058	0.43		1.30		1.46		2.11		2.11
	0.087	0.46		1.23		1.38		2.00		2.00
	0.12	0.47	0.44	1.19	1	1.34	0.72	1.93		1.93
	0.17	0.50		1.12		1.26		1.82		1.82
	0.29	0.55		1.02		1.14		1.66		1.66
	0.44	0.56	0.44	1.00	1	1.12	0.72	1.63		1.63
	0.58	0.56		1.00		1.12		1.63		1.63
	30°	—	0.8	0.39	0.76	1	0.78	0.63	1.24	
40°	—	1.14	0.35	0.57	1	0.55	0.57	0.93		0.93

Static equivalent radial load
P0r = X0Fr + Y0Fa

Contact angle	Single or DT	DB or DF	
		X0	Y0
		15°	0.5
30°	0.5	0.33	
40°	0.5	0.26	

Single or DT mounting When Por < X0Fr, use Pr = Fr

- i = 2 for DB or DF mounting
- i = 1 for Single or DT mounting
- Single or DT mounting When Fa/Fr ≤ e, use Pr = Fr

Boundary dimensions (mm)					Load center (mm) a	Bearing No.				Basic dynamic load rating Cr (N)		Basic static load rating Cor (N)		Limiting speed (min ⁻¹)				Abutment and fillet dimensions (mm)				Mass (kg) Single	Bearing No.		
d	D	B	r (min)	r1 (min)		Single	Duplex			Single	Duplex	Single	Duplex	Grease lubrication		Oil lubrication		da1 (min)	da2 (min)	Da1 (max)	Da2 (max)			ra (max)	ra1 (max)
							7020	7020DB	7020DF					7020DT	7200	7200DB	7200DF								
100	150	24	1.5	1	24.1	7020	7020DB	7020DF	7020DT	68500	111000	70500	141000	3600	2800	4800	3800	107	107	143	145.6	1.5	1	1.37	7020
	150	24	1.5	1	2.4	7020C	7020CDB	7020CDF	7020CDT	76000	123000	77500	156000	6400	5100	8800	7000	107	107	143	145.6	1.5	1	1.37	7020C
	180	34	2.1	1.1	23.4	7220	7220DB	7220DF	7220DT	144000	234000	126000	251000	3200	2400	4200	3400	112	107	168	173	2	1	3.32	7220
	180	34	2.1	1.1	41.8	7220B	7220BDB	7220BDF	7220BDT	135000	219000	118000	237000	2800	2200	3700	3000	112	107	168	173	2	1	3.32	7220B
	180	34	2.1	1.1	-0.8	7220C	7220CDB	7220CDF	7220CDT	150000	244000	128000	255000	5700	4600	7900	6300	112	112	168	173	2	1	3.32	7220C
	215	47	3	1.1	22.0	7320	7320DB	7320DF	7320DT	207000	335000	190000	380000	2800	2200	3800	3000	114	107	201	208	2.5	1	8.18	7320
	215	47	3	1.1	42.7	7320B	7320BDB	7320BDF	7320BDT	196000	320000	180000	360000	2400	2000	3300	2800	114	107	201	208	2.5	1	8.18	7320B
215	47	3	1.1	-5.3	7320C	7320CDB	7320CDF	7320CDT	211000	340000	197000	385000	5100	4100	7000	5600	114	114	201	208	2.5	1	8.18	7320C	
105	160	26	2	1	25.2	7021	7021DB	7021DF	7021DT	80000	130000	81500	163000	3300	2600	4400	3500	113	113	152	155	2	1	1.73	7021
	160	26	2	1	2.3	7021C	7021CDB	7021CDF	7021CDT	97000	158000	97500	195000	6000	4800	8300	6600	113	113	152	155	2	1	1.73	7021C
	190	36	2.1	1.1	24.6	7221	7221DB	7221DF	7221DT	157000	254000	141000	283000	3000	2400	4000	3200	117	112	178	183	2	1	3.93	7221
	190	36	2.1	1.1	44.0	7221B	7221BDB	7221BDF	7221BDT	147000	239000	135000	267000	2700	2100	3600	2900	117	112	178	183	2	1	3.93	7221B
	190	36	2.1	1.1	-0.9	7221C	7221CDB	7221CDF	7221CDT	163000	265000	144000	287000	5400	4300	7500	6000	117	117	178	183	2	1	3.93	7221C
	225	49	3	1.1	23.1	7321	7321DB	7321DF	7321DT	219000	355000	206000	410000	2700	2100	3600	2800	119	112	211	218	2.5	1	9.34	7321
	225	49	3	1.1	44.8	7321B	7321BDB	7321BDF	7321BDT	208000	335000	196000	390000	2400	1900	3200	2600	119	112	211	218	2.5	1	9.34	7321B
225	49	3	1.1	-5.3	7321C	7321CDB	7321CDF	7321CDT	224000	365000	212000	425000	4800	3800	6700	5400	119	119	211	218	2.5	1	9.34	7321C	
110	170	28	2	1	26.2	7022	7022DB	7022DF	7022DT	92000	149000	92500	185000	3200	2500	4300	3300	118	118	162	165	2	1	2.14	7022
	170	28	2	1	2.2	7022C	7022CDB	7022CDF	7022CDT	107000	173000	104000	209000	5700	4600	7900	6300	118	118	162	165	2	1	2.14	7022C
	200	38	2.1	1.1	25.7	7222	7222DB	7222DF	7222DT	170000	276000	158000	315000	2800	2200	3800	3000	122	117	188	193	2	1	4.62	7222
	200	38	2.1	1.1	46.1	7222B	7222BDB	7222BDF	7222BDT	159000	259000	149000	298000	2600	2000	3400	2800	122	117	188	193	2	1	4.62	7222B
	200	38	2.1	1.1	-1.0	7222C	7222CDB	7222CDF	7222CDT	171000	277000	157000	315000	5200	4200	7100	5700	122	122	188	193	2	1	4.62	7222C
	240	50	3	1.1	25.5	7322	7322DB	7322DF	7322DT	244000	395000	239000	480000	2600	2000	3400	2700	124	117	226	233	2.5	1	11.0	7322
	240	50	3	1.1	48.5	7322B	7322BDB	7322BDF	7322BDT	231000	375000	227000	455000	2200	1800	3000	2400	124	117	226	233	2.5	1	11.0	7322B
240	50	3	1.1	-4.7	7322C	7322CDB	7322CDF	7322CDT	237000	385000	227000	455000	4600	3700	6300	5000	124	124	226	233	2.5	1	11.0	7322C	
120	180	28	2	1	29.3	7024	7024DB	7024DF	7024DT	96500	157000	103000	206000	2900	2300	3800	3000	128	128	172	175	2	1	2.27	7024
	180	28	2	1	3.3	7024C	7024CDB	7024CDF	7024CDT	109000	178000	112000	223000	5300	4200	7300	5800	128	128	172	175	2	1	2.27	7024C
	215	40	2.1	1.1	28.4	7224	7224DB	7224DF	7224DT	182000	295000	180000	360000	2600	2100	3400	2700	132	127	203	208	2	1	6.05	7224
	215	40	2.1	1.1	50.3	7224B	7224BDB	7224BDF	7224BDT	170000	277000	169000	335000	2300	1900	3100	2500	132	127	203	208	2	1	6.05	7224B
	215	40	2.1	1.1	-0.6	7224C	7224CDB	7224CDF	7224CDT	185000	300000	176000	350000	4800	3800	6600	5300	132	132	203	208	2	1	6.05	7224C
	260	55	3	1.1	27.3	7324	7324DB	7324DF	7324DT	260000	420000	169000	540000	2200	1800	3000	2400	134	127	246	253	2.5	1	14.2	7324
	260	55	3	1.1	52.2	7324B	7324BDB	7324BDF	7324BDT	245000	400000	253000	505000	2100	1700	2800	2200	134	127	246	253	2.5	1	14.2	7324B

Remarks: 1. "a" means the distance between back face and load center.
2. See page 122 regarding limiting speeds.

Angular Contact Ball Bearings Single Mounting / Duplex Mounting

Bore Diameter: 130~160mm

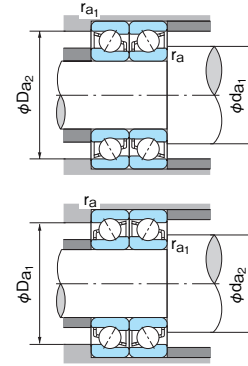
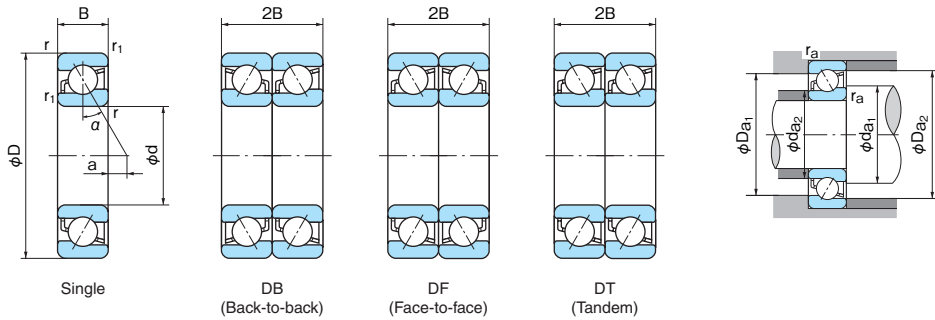

Dynamic equivalent radial load
 $P_r = XFr + YFa$

Contact angle	iFa Cor	e	Single or DT		DB or DF				
			$\frac{Fa}{Fr} > e$		$\frac{Fa}{Fr} \leq e$		$\frac{Fa}{Fr} > e$		
			X	Y	X	Y	X	Y	
15°	0.015	0.38			1.47	1.65			2.39
	0.029	0.40	0.44	1.40	1	1.57	0.72	2.28	2.28
	0.058	0.43		1.30		1.46		2.11	
	0.087	0.46		1.23		1.38		2.00	
	0.12	0.47	0.44	1.19	1	1.34	0.72	1.93	
	0.17	0.50		1.12		1.26		1.82	
	0.29	0.55		1.02		1.14		1.66	
	0.44	0.56	0.44	1.00	1	1.12	0.72	1.63	
	0.58	0.56		1.00		1.12		1.63	
	0.58	0.56		1.00		1.12		1.63	
30°	—	0.8	0.39	0.76	1	0.78	0.63	1.24	
40°	—	1.14	0.35	0.57	1	0.55	0.57	0.93	

Static equivalent radial load
 $P_{or} = X_0Fr + Y_0Fa$

Contact angle	Single or DT		DB or DF	
	X ₀	Y ₀	X ₀	Y ₀
15°	0.5	0.46	1	0.92
30°	0.5	0.33	1	0.66
40°	0.5	0.26	1	0.52

Single or DT mounting When $P_{or} < Fr$, use $P_r = Fr$

i = 2 for DB or DF mounting
 i = 1 for Single or DT mounting
 Single or DT mounting When $Fa/Fr \leq e$, use $P_r = Fr$

Boundary dimensions (mm)						Load center (mm) a	Bearing No.				Basic dynamic load rating Cr (N)		Basic static load rating Cor (N)	Limiting speed (min ⁻¹)				Abutment and fillet dimensions (mm)						Mass (kg) Single	Bearing No.
d	D	B	r (min)	r ₁ (min)			Single	Duplex			Single	Duplex		Grease lubrication		Oil lubrication		d _{a1} (min)	d _{a2} (min)	D _{a1} (max)	D _{a2} (max)	r _a (max)	r _{a1} (max)		
130	200	33	2	1	31.1	7026	7026DB	7026DF	7026DT	117000	190000	125000	250000	2600	2200	3600	2700	138	138	192	195	2	1	3.43	7026
	200	33	2	1	2.5	7026C	7026CDB	7026CDF	7026CDT	130000	211000	138000	276000	4800	3800	6700	5400	138	138	192	195	2	1	3.43	7026C
	230	40	3	1.1	32	7226	7226DB	7226DF	7226DT	196000	320000	198000	395000	2400	1900	3100	2500	144	137	216	223	2.5	1	6.88	7226
	230	40	3	1.1	55.5	7226B	7226BDB	7226BDF	7226BDT	184000	298000	185000	370000	2100	1700	2800	2300	144	137	216	223	2.5	1	6.88	7226B
	230	40	3	1.1	0.9	7226C	7226CDB	7226CDF	7226CDT	214000	350000	216000	430000	4400	3500	6100	4900	144	144	216	223	2.5	1	6.88	7226C
	280	58	4	1.5	30.2	7326	7326DB	7326DF	7326DT	300000	490000	330000	660000	2200	1700	2900	2200	148	139	262	271	3	1.5	17.4	7326
	280	58	4	1.5	57.0	7326B	7326BDB	7326BDF	7326BDT	284000	460000	310000	620000	1900	1500	2600	2000	148	139	262	271	3	1.5	17.4	7326B
140	210	33	2	1	34	7028	7028DB	7028DF	7028DT	120000	194000	133000	265000	2400	1900	3300	2600	148	148	202	205	2	1	3.63	7028
	210	33	2	1	3.7	7028C	7028CDB	7028CDF	7028CDT	133000	216000	146000	292000	4600	3700	6300	5000	148	148	202	205	2	1	3.63	7028C
	250	42	3	1.1	35.3	7228	7228DB	7228DF	7228DT	211000	345000	228000	525000	2200	1800	3000	2400	154	147	236	243	2.5	1	8.78	7228
	250	42	3	1.1	60.8	7228B	7228BDB	7228BDF	7228BDT	197000	320000	214000	425000	2000	1600	2600	2200	154	147	236	243	2.5	1	8.78	7228B
	250	42	3	1.1	1.3	7228C	7228CDB	7228CDF	7228CDT	223000	360000	235000	470000	4100	3300	5600	4500	154	154	236	243	2.5	1	8.78	7228C
	300	62	4	1.5	32.5	7328	7328DB	7328DF	7328DT	300000	490000	335000	670000	2000	1600	2600	2000	158	149	282	291	3	1.5	21.5	7328
	300	62	4	1.5	61.3	7328B	7328BDB	7328BDF	7328BDT	284000	460000	315000	635000	1700	1400	2400	1900	158	149	282	291	3	1.5	21.5	7328B
150	225	35	2.1	1.1	36.6	7030	7030DB	7030DF	7030DT	137000	222000	154000	305000	2300	1800	3000	2400	159	159	216	219	2	1	4.42	7030
	225	35	2.1	1.1	4.1	7030C	7030CDB	7030CDF	7030CDT	152000	247000	169000	340000	4300	3400	5900	4700	159	159	216	219	2	1	4.42	7030C
	270	45	3	1.1	38.1	7230	7230DB	7230DF	7230DT	249000	405000	280000	560000	2000	1600	2800	2200	164	157	256	263	2.5	1	11.0	7230
	270	45	3	1.1	65.6	7230B	7230BDB	7230BDF	7230BDT	223000	360000	246000	490000	1800	1500	2600	2000	164	157	256	263	2.5	1	11.0	7230B
	270	45	3	1.1	1.5	7230C	7230CDB	7230CDF	7230CDT	261000	425000	287000	575000	3800	3000	5200	4200	164	164	256	263	2.5	1	11.0	7230C
	320	65	4	1.5	35.3	7330	7330DB	7330DF	7330DT	330000	535000	380000	765000	1700	1400	2400	1800	168	159	302	311	3	1.5	25.1	7330
	320	65	4	1.5	66.1	7330B	7330BDB	7330BDF	7330BDT	310000	505000	360000	725000	1500	1300	2200	1600	168	159	302	311	3	1.5	25.1	7330B
160	240	38	2.1	1.1	38.7	7032	7032DB	7032DF	7032DT	155000	252000	176000	350000	2100	1700	2800	2300	169	169	231	234	2	1	5.44	7032
	240	38	2.1	1.1	4.1	7032C	7032CDB	7032CDF	7032CDT	172000	280000	194000	390000	4000	3200	5500	4400	169	169	231	234	2	1	5.44	7032C
	290	48	3	1.1	41.0	7232	7232DB	7232DF	7232DT	263000	425000	305000	615000	1900	1500	2600	2000	174	167	276	283	2.5	1	13.7	7232
	290	48	3	1.1	70.4	7232B	7232BDB	7232BDF	7232BDT	246000	400000	287000	575000	1700	1400	2200	1800	174	167	276	283	2.5	1	13.7	7232B
	290	48	3	1.1	2.4	7232C	7232CDB	7232CDF	7232CDT	288000	470000	335000	670000	3600	2900	4900	3900	174	167	276	283	2.5	1	13.7	7232C
	340	68	4	1.5	38.2	7332	7332DB	7332DF	7332DT	345000	565000	420000	845000	1700	1400	2200	1800	178	169	322	331	3	1.5	30.2	7332
	340	68	4	1.5	70.9	7332B	7332BDB	7332BDF	7332BDT	325000	530000	395000	795000	1500	1200	2000	1600	178	169	322	331	3	1.5	30.2	7332B

Remarks: 1. "a" means the distance between back face and load center.
 2. See page 122 regarding limiting speeds.

Angular Contact Ball Bearings Single Mounting / Duplex Mounting

Bore Diameter: 170~200mm

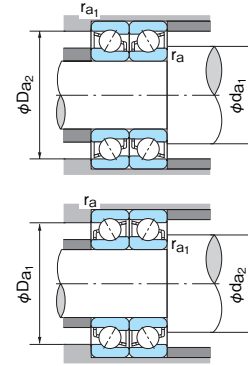
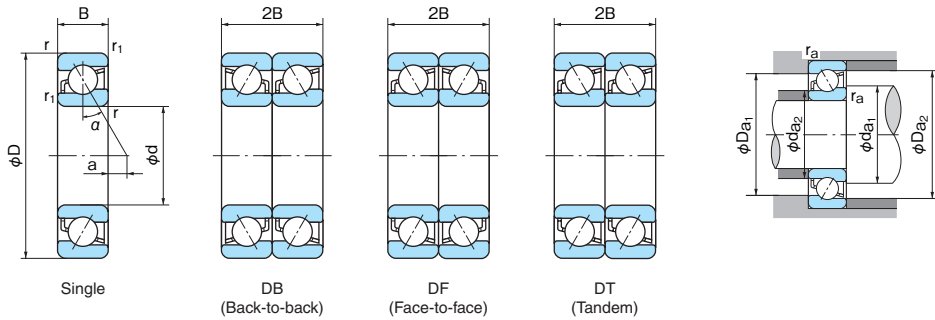

Dynamic equivalent radial load
 $P_r = XFr + YFa$

Contact angle	iFa Cor	e	Single or DT		DB or DF				
			$\frac{Fa}{Fr} > e$		$\frac{Fa}{Fr} \leq e$		$\frac{Fa}{Fr} > e$		
			X	Y	X	Y	X	Y	
15°	0.015	0.38			1.47	1.65			2.39
	0.029	0.40	0.44	1.40	1	1.57	0.72	2.28	
	0.058	0.43		1.30		1.46		2.11	
	0.087	0.46		1.23		1.38		2.00	
	0.12	0.47	0.44	1.19	1	1.34	0.72	1.93	
	0.17	0.50		1.12		1.26		1.82	
	0.29	0.55		1.02		1.14		1.66	
	0.44	0.56	0.44	1.00	1	1.12	0.72	1.63	
	0.58	0.56		1.00		1.12		1.63	
	30°	—	0.8	0.39	0.76	1	0.78	0.63	1.24
40°	—	—	1.14	0.35	0.57	1	0.55	0.57	0.93

Static equivalent radial load
 $P_{or} = X_0Fr + Y_0Fa$

Contact angle	Single or DT		DB or DF	
	X_0	Y_0	X_0	Y_0
15°	0.5	0.46	1	0.92
30°	0.5	0.33	1	0.66
40°	0.5	0.26	1	0.52

Single or DT mounting When $P_{or} < Fr$, use $P_r = Fr$

i = 2 for DB or DF mounting
 i = 1 for Single or DT mounting
 Single or DT mounting When $Fa/Fr \leq e$, use $P_r = Fr$

Boundary dimensions (mm)						Load center (mm) a	Bearing No.				Basic dynamic load rating Cr (N)		1N=0.102kgf		Limiting speed (min ⁻¹)				Abutment and fillet dimensions (mm)				Mass (kg) Single	Bearing No.	
d	D	B	r (min)	r ₁ (min)			Single	Duplex			Single	Duplex	Single	Duplex	Grease lubrication		Oil lubrication		d _{a1} (min)	d _{a2} (min)	D _{a1} (max)	D _{a2} (max)			r _a (max)
170	260	42	2.1	1.1	41.1	7034	7034DB	7034DF	7034DT	179000	291000	210000	420000	2000	1600	2600	2100	179	179	251	254	2	1	7.87	7034
	260	42	2.1	1.1	3.8	7034C	7034CDB	7034CDF	7034CDT	206000	335000	236000	470000	3700	3000	5100	4100	179	179	251	254	2	1	7.87	7034C
	310	52	4	1.5	43.3	7234	7234DB	7234DF	7234DT	272000	440000	330000	660000	1800	1400	2400	1900	188	179	292	301	3	1.5	17.4	7234
	310	52	4	1.5	74.7	7234B	7234BDB	7234BDF	7234BDT	254000	410000	310000	620000	1600	1300	2200	1700	188	179	292	301	3	1.5	17.4	7234B
	310	52	4	1.5	2.2	7234C	7234CDB	7234CDF	7234CDT	299000	485000	360000	725000	3300	2600	4600	3700	188	179	292	301	3	1.5	17.4	7234C
	360	72	4	1.5	40.5	7334	7334DB	7334DF	7334DT	390000	630000	485000	970000	1600	1300	2200	1700	188	179	342	351	3	1.5	35.7	7334
	360	72	4	1.5	75.2	7334B	7334BDB	7334BDF	7334BDT	365000	595000	460000	915000	1400	1100	2000	1600	188	179	342	351	3	1.5	35.7	7334B
180	280	46	2.1	1.1	43.4	7036	7036DB	7036DF	7036DT	207000	335000	252000	505000	1900	1500	2500	2000	189	189	271	274	2	1	9.98	7036
	280	46	2.1	1.1	3.5	7036C	7036CDB	7036CDF	7036CDT	235000	385000	290000	580000	3500	2800	4800	3800	189	189	271	274	2	1	9.98	7036C
	320	52	4	1.5	46.2	7236	7236DB	7236DF	7236DT	281000	455000	350000	705000	1700	1300	2200	1800	198	189	302	311	3	1.5	19.9	7236
	320	52	4	1.5	48.9	7236B	7236BDB	7236BDF	7236BDT	262000	425000	330000	660000	1500	1200	2000	1700	198	189	302	311	3	1.5	19.9	7236B
	320	52	4	1.5	3.3	7236C	7236CDB	7236CDF	7236CDT	310000	500000	385000	775000	3200	2600	4400	3500	198	189	302	311	3	1.5	19.9	7236C
	380	75	4	1.5	43.3	7336	7336DB	7336DF	7336DT	410000	665000	535000	1070000	1400	1200	2000	1600	198	189	362	371	3	1.5	41.3	7336
	380	75	4	1.5	80.0	7336B	7336BDB	7336BDF	7336BDT	385000	625000	505000	1010000	1300	1100	1900	1500	198	189	362	371	3	1.5	41.3	7336B
190	290	46	2.1	1.1	46.3	7038	7038DB	7038DF	7038DT	218000	355000	277000	555000	1800	1400	2300	1900	199	199	281	284	2	1	10.7	7038
	290	46	2.1	1.1	4.7	7038C	7038CDB	7038CDF	7038CDT	248000	405000	310000	615000	3300	2600	4600	3700	199	199	281	284	2	1	10.7	7038C
	340	55	4	1.5	49.0	7238	7238DB	7238DF	7238DT	315000	510000	410000	825000	1600	1300	2200	1700	208	199	322	331	3	1.5	21.5	7238
	340	55	4	1.5	83.7	7238B	7238BDB	7238BDF	7238BDT	294000	475000	385000	770000	1400	1100	2000	1600	208	199	322	331	3	1.5	21.5	7238B
	400	78	5	2	46.1	7338	7338DB	7338DF	7338DT	445000	725000	610000	1220000	1400	1100	1900	1500	212	200	378	390	4	2	47.6	7338
	400	78	5	2	84.8	7338B	7338BDB	7338BDF	7338BDT	420000	680000	575000	1150000	1300	1000	1800	1400	212	200	378	390	4	2	47.6	7338B
200	310	51	2.1	1.1	48.1	7040	7040DB	7040DF	7040DT	226000	365000	277000	565000	1700	1300	2200	1800	209	209	301	304	2	1	13.8	7040
	310	51	2.1	1.1	3.9	7040C	7040CDB	7040CDF	7040CDT	274000	445000	360000	715000	3100	2500	4300	3400	209	209	301	304	2	1	13.8	7040C
	360	58	4	1.5	51.8	7240	7240DB	7240DF	7240DT	335000	550000	450000	900000	1500	1200	2000	1600	218	209	342	351	3	1.5	25.5	7240
	360	58	4	1.5	88.5	7240B	7240BDB	7240BDF	7240BDT	315000	510000	420000	840000	1300	1000	1900	1500	218	209	342	351	3	1.5	25.5	7240B
	420	80	5	2	49.5	7340	7340DB	7340DF	7340DT	475000	770000	655000	1310000	1300	1100	1800	1400	222	210	398	410	4	2	53.7	7340
	420	80	5	2	90.1	7340B	7340BDB	7340BDF	7340BDT	445000	725000	620000	1240000	1200	1000	1700	1300	222	210	398	410	4	2	53.7	7340B

Remarks: 1. "a" means the distance between back face and load center.
 2. See page 122 regarding limiting speeds.

Double-row Angular Contact Ball Bearings

Bore Diameter: 10~45mm

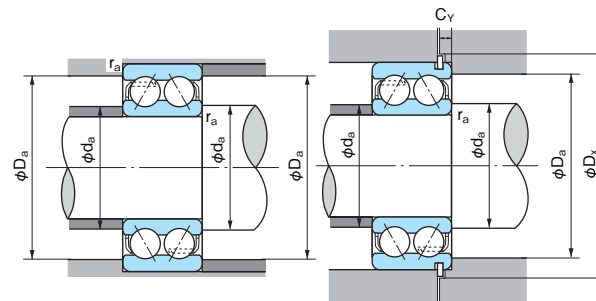
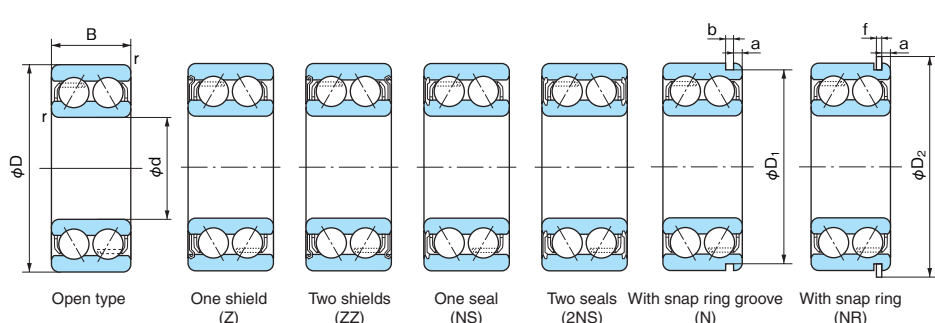

■ Dynamic equivalent radial load
 $P_r = XFr + YFa$

Contact angle	e	$\frac{Fa}{Fr} \leq e$		$\frac{Fa}{Fr} > e$	
		X	Y	X	Y
30°	0.80	1.0	0.78	0.63	1.24
20°	0.57	1.0	1.09	0.70	1.63

■ Static equivalent radial load

Nominal contact angle 30° : $P_{or} = Fr + 0.66Fa$
 Nominal contact angle 20° : $P_{or} = Fr + 0.84Fa$

1N=0.102kgf

Boundary dimensions (mm)				Bearing No.								Basic dynamic load rating Cr (N)	Basic static load rating Cor (N)	Limiting speed (min ⁻¹)		Dimensions of snap ring groove and snap ring (mm)						Abutment and fillet dimensions (mm)					Mass (kg)	Bearing No.
d	D	B	r (min)	Open type	Shield type		Seal type		With snap ring groove	With snap ring	Grease lubrication			Oil lubrication	D ₁ (max)	a (max)	b (min)	D ₂ (max)	f (max)	d _a (min)	D _a (max)	D _x (min)	r _a (max)	C _y (max)				
10	30	14.3	0.6	5200	5200Z	5200ZZ	5200NS	5200-2NS	5200N	5200NR	7300	4000	18000	24000	28.17	2.06	1.35	34.7	1.12	15	25	35.5	0.6	2.9	0.050	5200		
	30	14.3	0.6	5200A	5200AZ	5200AZZ	5200ANS	5200A-2NS	5200AN	5200ANR	6950	3800	16000	22000	28.17	2.06	1.35	34.7	1.12	15	25	35.5	0.6	2.9	0.050	5200A		
12	32	15.9	0.6	5201	5201Z	5201ZZ	5201NS	5201-2NS	5201N	5201NR	10700	5950	16000	22000	30.15	2.06	1.35	36.7	1.12	17	27	37.5	0.6	2.9	0.060	5201		
	32	15.9	0.6	5201A	5201AZ	5201AZZ	5201ANS	5201A-2NS	5201AN	5201ANR	10300	5650	15000	20000	30.15	2.06	1.35	36.7	1.12	17	27	37.5	0.6	2.9	0.060	5201A		
15	35	15.9	0.6	5202	5202Z	5202ZZ	5202NS	5202-2NS	5202N	5202NR	11900	7200	14000	19000	33.17	2.06	1.35	39.7	1.12	20	30	40.5	0.6	2.9	0.070	5202		
	35	15.9	0.6	5202A	5202AZ	5202AZZ	5202ANS	5202A-2NS	5202AN	5202ANR	11400	6850	12000	17000	33.17	2.06	1.35	39.7	1.12	20	30	40.5	0.6	2.9	0.070	5202A		
17	40	17.5	0.6	5203	5203Z	5203ZZ	5203NS	5203-2NS	5203N	5203NR	15000	9250	12000	17000	38.1	2.06	1.35	44.6	1.12	22	35	45.5	0.6	2.9	0.090	5203		
	40	17.5	0.6	5203A	5203AZ	5203AZZ	5203ANS	5203A-2NS	5203AN	5203ANR	14200	8800	11000	15000	38.1	2.06	1.35	44.6	1.12	22	35	45.5	0.6	2.9	0.090	5203A		
	47	22.2	1	5303	—	—	—	—	5303N	5303NR	21300	12700	10000	14000	44.6	2.46	1.35	52.7	1.12	23	41	53.5	1	3.3	0.140	5303		
20	47	20.6	1	5204	5204Z	5204ZZ	5204NS	5204-2NS	5204N	5204NR	20000	12700	10000	14000	44.6	2.46	1.35	52.7	1.12	26	41	53.5	1	3.3	0.120	5204		
	47	20.6	1	5204A	5204AZ	5204AZZ	5204ANS	5204A-2NS	5204AN	5204ANR	19000	12100	9500	13000	44.6	2.46	1.35	52.7	1.12	26	41	53.5	1	3.3	0.120	5204A		
	52	22.2	1.1	5304	—	—	—	—	5304N	5304NR	21700	13300	9000	11000	49.73	2.46	1.35	57.9	1.12	27	45	58.5	1	3.3	0.230	5304		
25	52	20.6	1	5205	5205Z	5205ZZ	5205NS	5205-2NS	5205N	5205NR	21800	15100	9500	13000	49.73	2.46	1.35	57.9	1.12	31	46	58.5	1	3.3	0.190	5205		
	52	20.6	1	5205A	5205AZ	5205AZZ	5205ANS	5205A-2NS	5205AN	5205ANR	20600	14300	8000	11000	49.73	2.46	1.35	57.9	1.12	31	46	58.8	1	3.3	0.190	5205A		
	62	25.4	1.1	5305	—	—	—	—	5305N	5305NR	32000	21600	7300	10000	59.61	3.28	1.9	67.7	1.7	32	55	68.5	1	4.7	0.340	5305		
30	62	23.8	1	5206	—	—	—	—	5206N	5206NR	30500	21700	8000	11000	59.61	3.28	1.9	67.7	1.7	36	56	68.5	1	4.7	0.290	5206		
	62	23.8	1	—	5206Z	5206ZZ	5206NS	5206-2NS	—	—	25900	18700	8000	—	—	—	—	—	36	56	—	1	—	—	0.290	5206Z		
	62	23.8	1	5206A	—	—	—	—	5206AN	5206ANR	28600	20500	7000	9500	59.61	3.28	1.9	67.7	1.7	36	56	68.5	1	4.7	0.290	5206A		
	62	23.8	1	—	5206AZ	5206AZZ	5206ANS	5206A-2NS	—	—	24400	17700	7000	—	—	—	—	—	36	56	—	1	—	—	0.290	5206AZ		
	72	30.2	1.1	5306	—	—	—	—	5306N	5306NR	41500	29000	7000	9500	68.81	3.28	1.9	78.6	1.7	37	65	80	1	4.7	0.510	5306		
35	72	27	1.1	5207	—	—	—	—	5207N	5207NR	40000	29500	7000	9500	68.81	3.28	1.9	78.6	1.7	42	65	80	1	4.7	0.430	5207		
	72	27	1.1	—	5207Z	5207ZZ	5207NS	5207-2NS	—	—	35000	25900	7000	—	—	—	—	—	42	65	—	1	—	—	0.430	5207Z		
	72	27	1.1	5207A	—	—	—	—	5207AN	5207ANR	38000	27700	6000	8000	68.81	3.28	1.9	78.6	1.7	42	65	80	1	4.7	0.430	5207A		
	72	27	1.1	—	5207AZ	5207AZZ	5207ANS	5207A-2NS	—	—	33000	24500	6000	—	—	—	—	—	42	65	—	1	—	—	0.430	5207AZ		
	80	34.9	1.5	5307	—	—	—	—	5307N	5307NR	52000	37000	6300	8500	76.81	3.28	1.9	86.6	1.7	44	71	88	1.5	4.7	0.790	5307		
40	80	30.2	1.1	5208	—	—	—	—	5208N	5208NR	45500	34000	6000	8000	76.81	3.28	1.9	86.6	1.7	47	73	88	1	4.7	0.570	5208		
	80	30.2	1.1	—	5208Z	5208ZZ	5208NS	5208-2NS	—	—	40000	30500	6000	—	—	—	—	—	47	73	—	1	—	—	0.570	5208Z		
	80	30.2	1.1	5208A	—	—	—	—	5208AN	5208ANR	42500	32500	5300	7200	76.81	3.28	1.9	86.6	1.7	47	73	88	1	4.7	0.570	5208A		
	80	30.2	1.1	—	5208AZ	5208AZZ	5208ANS	5208A-2NS	—	—	37500	28700	5300	—	—	—	—	—	47	73	—	1	—	—	0.570	5208AZ		
	90	36.5	1.5	5308	—	—	—	—	5308N	5308NR	63500	46500	5500	7500	86.79	3.28	2.7	96.5	2.46	49	81	98	1.5	5.4	1.05	5308		
45	85	30.2	1.1	5209	—	—	—	—	5209N	5209NR	51000	39000	5500	7500	81.81	3.28	1.9	91.6	1.7	52	78	93	1	4.7	0.620	5209		
	85	30.2	1.1	—	5209Z	5209ZZ	5209NS	5209-2NS	—	—	42500	34500	5500	—	—	—	—	—	52	78	—	1	—	—	0.620	5209Z		
	85	30.2	1.1	5209A	—	—	—	—	5209AN	5209ANR	48000	37000	5000	6700	81.81	3.28	1.9	91.6	1.7	52	78	93	1	4.7	0.620	5209A		
	85	30.2	1.1	—	5209AZ	5209AZZ	5209ANS	5209A-2NS	—	—	40000	32500	5000	—	—	—	—	—	52	78	—	1	—	—	0.620	5209AZ		
100	39.7	1.5	5309	—	—	—	—	5309N	5309NR	76500	56500	5000	6700	96.8	3.28	2.7	106.5	2.46	54	91	108	1.5	5.4	1.42	5309			

Remark: Dimensions and tolerances of snap ring groove and snap ring are shown on pages 45 to 48.

Double-row Angular Contact Ball Bearings

Bore Diameter: 50~85mm

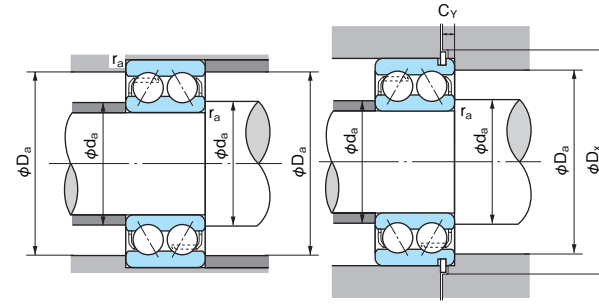
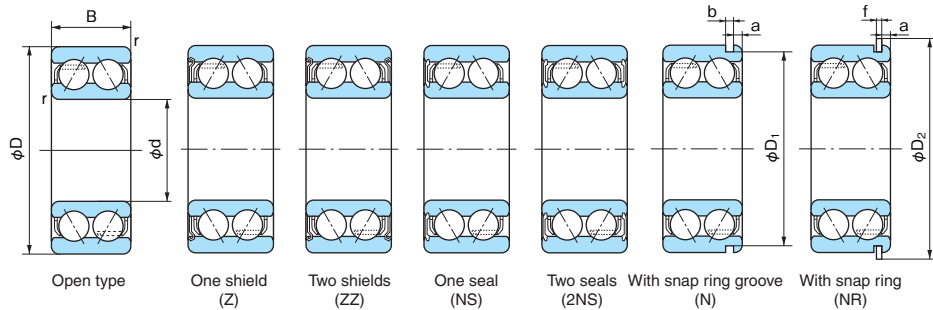

Dynamic equivalent radial load
 $P_r = X F_r + Y F_a$

Contact angle	e	$\frac{F_a}{F_r} \leq e$		$\frac{F_a}{F_r} > e$	
		X	Y	X	Y
30°	0.80	1.0	0.78	0.63	1.24
20°	0.57	1.0	1.09	0.70	1.63

Static equivalent radial load

Nominal contact angle 30° : $P_{or} = F_r + 0.66 F_a$
 Nominal contact angle 20° : $P_{or} = F_r + 0.84 F_a$

1N=0.102kgf

Boundary dimensions (mm)				Bearing No.							Basic dynamic load rating Cr (N)	Basic static load rating Cor (N)	Limiting speed (min ⁻¹)		Dimensions of snap ring groove and snap ring (mm)						Abutment and fillet dimensions (mm)					Mass (kg)	Bearing No.
d	D	B	r (min)	Open type	Shield type		Seal type		With snap ring groove	With snap ring			Grease lubrication	Oil lubrication	D ₁ (max)	a (max)	b (min)	D ₂ (max)	f (max)	d _a (min)	D _a (max)	D _x (min)	r _a (max)	C _γ (max)			
50	90	30.2	1.1	5210	—	—	—	—	5210N	5210NR	54500	44500	5000	6700	86.79	3.28	2.7	96.5	2.46	57	83	98	1	5.4	0.670	5210	
	90	30.2	1.1	—	5210Z	5210ZZ	5210NS	5210-2NS	—	—	45000	39000	5000	—	—	—	—	—	—	57	83	—	1	—	0.670	5210Z	
	90	30.2	1.1	5210A	—	—	—	—	5210AN	5210ANR	51000	42000	4500	6000	86.79	3.28	2.7	96.5	2.46	57	83	98	1	5.4	0.670	5210A	
	90	30.2	1.1	—	5210AZ	5210AZZ	5210ANS	5210A-2NS	—	—	42000	36500	4500	—	—	—	—	—	—	57	83	—	1	—	0.670	5210AZ	
	110	44.4	2	5310	—	—	—	—	5310N	5310NR	90000	68000	4500	6000	106.81	3.28	2.7	116.6	2.46	60	100	118	2	5.4	1.93	5310	
55	100	33.3	1.5	5211	—	—	—	—	5211N	5211NR	67500	56500	4500	6300	96.8	3.28	2.7	106.5	2.46	64	91	108	1.5	5.4	0.960	5211	
	100	33.3	1.5	—	5211Z	5211ZZ	—	—	—	—	57500	50500	4500	—	—	—	—	—	64	91	—	1.5	—	0.960	5211Z		
	100	33.3	1.5	5211A	—	—	—	—	5211AN	5211ANR	63500	53000	4000	5500	96.8	3.28	2.7	106.5	2.46	64	91	108	1.5	5.4	0.960	5211A	
	100	33.3	1.5	—	5211AZ	5211AZZ	—	—	—	—	54000	47500	4000	—	—	—	—	—	64	91	—	1.5	—	0.960	5211AZ		
	120	49.2	2	5311	—	—	—	—	5311N	5311NR	112000	86500	4000	5500	115.21	4.06	3.1	129.7	2.82	65	110	131.5	2	6.5	2.30	5311	
60	110	36.5	1.5	5212	—	—	—	—	5212N	5212NR	76000	62000	4300	5600	106.81	3.28	2.7	116.6	2.46	69	101	118	1.5	5.4	1.36	5212	
	110	36.5	1.5	—	5212Z	5212ZZ	—	—	—	—	67000	57500	4300	—	—	—	—	—	69	101	—	1.5	—	1.36	5212Z		
	110	36.5	1.5	5212A	—	—	—	—	5212AN	5212ANR	71500	58500	3800	5000	106.81	3.28	2.7	116.6	2.46	69	101	118	1.5	5.4	1.36	5212A	
	110	36.5	1.5	—	5212AZ	5212AZZ	—	—	—	—	63000	54000	3800	—	—	—	—	—	69	101	—	1.5	—	1.36	5212AZ		
	130	54	2.1	5312	—	—	—	—	5312N	5312NR	128000	101000	3800	5000	125.22	4.06	3.1	139.7	2.82	72	118	141.5	2	6.5	3.16	5312	
65	120	38.1	1.5	5213	—	—	—	—	5213N	5213NR	89000	77000	3900	5300	115.21	4.06	3.1	129.7	2.82	74	111	131.5	1.5	6.5	1.66	5213	
	120	38.1	1.5	—	5213Z	5213ZZ	—	—	—	—	78500	71000	3900	—	—	—	—	—	74	111	—	1.5	—	1.66	5213Z		
	120	38.1	1.5	5213A	—	—	—	—	5213AN	5213ANR	83500	72500	3400	4600	115.21	4.06	3.1	129.7	2.82	74	111	131.5	1.5	6.5	1.66	5213A	
	120	38.1	1.5	—	5213AZ	5213AZZ	—	—	—	—	73500	66500	3400	—	—	—	—	—	74	111	—	1.5	—	1.66	5213AZ		
	140	58.7	2.1	5313	—	—	—	—	5313N	5313NR	145000	115000	3600	4700	135.23	4.9	3.1	149.7	2.82	77	128	152	2	7.4	3.86	5313	
70	125	39.7	1.5	5214	—	—	—	—	5214N	5214NR	96500	84500	3800	5000	120.22	4.06	3.1	134.7	2.82	79	116	136.5	1.5	6.5	1.82	5214	
	125	39.7	1.5	—	5214Z	5214ZZ	—	—	—	—	86000	79000	3800	—	—	—	—	—	79	116	—	1.5	—	1.82	5214Z		
	125	39.7	1.5	5214A	—	—	—	—	5214AN	5214ANR	90500	79500	3200	4500	120.22	4.06	3.1	134.7	2.82	79	116	136.5	1.5	6.5	1.82	5214A	
	125	39.7	1.5	—	5214AZ	5214AZZ	—	—	—	—	80500	74000	3200	—	—	—	—	—	79	116	—	1.5	—	1.82	5214AZ		
	150	63.5	2.1	5314	—	—	—	—	5314N	5314NR	163000	132000	3200	4300	145.24	4.9	3.1	159.7	2.82	82	138	162	2	7.4	4.88	5314	
75	130	41.3	1.5	5215	—	—	—	—	5215N	5215NR	96000	85500	3400	4700	125.22	4.06	3.1	139.7	2.82	84	121	141.5	1.5	6.5	1.91	5215	
	130	41.3	1.5	—	5215Z	5215ZZ	—	—	—	—	94000	87000	3400	—	—	—	—	—	84	121	—	1.5	—	1.91	5215Z		
	130	41.3	1.5	5215A	—	—	—	—	5215AN	5215ANR	90000	80500	3200	4300	125.22	4.06	3.1	139.7	2.82	84	121	141.5	1.5	6.5	1.91	5215A	
	130	41.3	1.5	—	5215AZ	5215AZZ	—	—	—	—	88000	81500	3200	—	—	—	—	—	84	121	—	1.5	—	1.91	5215AZ		
	160	68.3	2.1	5315	—	—	—	—	5315N	5315NR	178000	149000	3000	4000	155.22	4.9	3.1	169.7	2.82	87	148	172	2	7.4	5.51	5315	
80	140	44.4	2	5216	—	—	—	—	5216N	5216NR	104000	94000	3500	4600	135.23	4.9	3.1	149.7	2.82	90	130	152	2	7.4	2.48	5216	
	140	44.4	2	5216A	—	—	—	—	5216AN	5216ANR	97500	88500	2800	4000	135.23	4.9	3.1	149.7	2.82	90	130	152	2	7.4	2.48	5216A	
	170	68.3	2.1	5316	—	—	—	—	5316N	5316NR	192000	167000	2800	4000	163.65	5.69	3.5	182.9	3.1	92	158	185	2	8.4	6.81	5316	
85	150	49.2	2	5217	—	—	—	—	5217N	5217NR	112000	103000	3000	4000	145.24	4.9	3.1	159.7	2.82	95	140	162	2	7.4	3.40	5217	
	150	49.2	2	5217A	—	—	—	—	5217AN	5217ANR	105000	96500	2600	3800	145.24	4.9	3.1	159.7	2.82	95	140	162	2	7.4	3.40	5217A	

Remark: Dimensions and tolerances of snap ring groove and snap ring are shown on pages 45 to 48.

Double-row Angular Contact Ball Bearings

Bore Diameter: 90~100mm

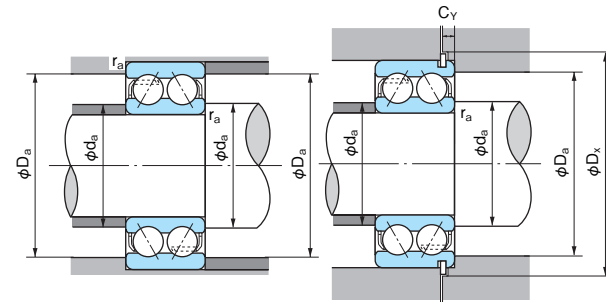
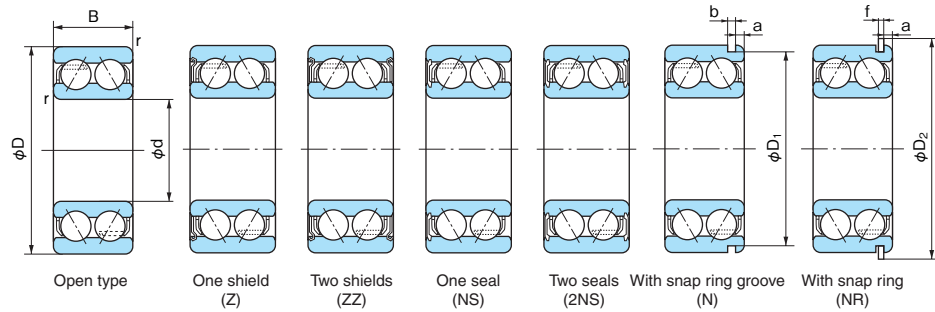

■ **Dynamic equivalent radial load**
 $P_r = XFr + YFa$

Contact angle	e	$\frac{Fa}{Fr} \leq e$		$\frac{Fa}{Fr} > e$	
		X	Y	X	Y
30°	0.80	1.0	0.78	0.63	1.24
20°	0.57	1.0	1.09	0.70	1.63

■ **Static equivalent radial load**
 Nominal contact angle 30° : $P_{or} = Fr + 0.66Fa$
 Nominal contact angle 20° : $P_{or} = Fr + 0.84Fa$

1N=0.102kgf

Boundary dimensions (mm)				Bearing No.								Basic dynamic load rating Cr (N)	Basic static load rating Cor (N)	Limiting speed (min ⁻¹)		Dimensions of snap ring groove and snap ring (mm)					Abutment and fillet dimensions (mm)					Mass (kg)	Bearing No.
d	D	B	r (min)	Open type	Shield type		Seal type		With snap ring groove	With snap ring	Grease lubrication			Oil lubrication	D ₁ (max)	a (max)	b (min)	D ₂ (max)	f (max)	d _a (min)	D _a (max)	D _x (min)	r _a (max)	C _γ (max)			
90	160	52.4	2	5218	—	—	—	—	5218N	5218NR	138000	133000	2700	3900	155.22	4.9	3.1	169.7	2.82	100	150	172	2	7.4	4.28	5218	
	160	52.4	2	5218A	—	—	—	—	5218AN	5218ANR	129000	125000	2500	3500	155.22	4.9	3.1	169.7	2.82	100	150	172	2	7.4	4.28	5218A	
95	170	55.6	2.1	5219	—	—	—	—	5219N	5219NR	149000	139000	2600	3700	163.65	5.69	3.5	182.9	3.1	107	158	185	2	8.4	5.02	5219	
	170	55.6	2.1	5219A	—	—	—	—	5219AN	5219ANR	139000	131000	2400	3200	163.65	5.69	3.5	182.9	3.1	107	158	185	2	8.4	5.02	5219A	
100	180	60.3	2.1	5220	—	—	—	—	5220N	5220NR	168000	159000	2400	3200	173.66	5.69	3.5	192.9	3.1	112	168	195	2	8.4	5.78	5220	
	180	60.3	2.1	5220A	—	—	—	—	5220AN	5220ANR	158000	150000	2200	3000	173.66	5.69	3.5	192.9	3.1	112	168	195	2	8.4	5.78	5220A	

Remark: Dimensions and tolerances of snap ring groove and snap ring are shown on pages 45 to 48.